

# High Quality Dental Instruments

**HUZAIFA**  
INTERNATIONAL



ایوان معیشت و تجارت سیالکوٹ



✉ info@huzafaint.com

☎ +92 319 1831970

🌐 www.huzafaint.com



**Address:**

Shahid hamber, Nawa pind araiyan  
Defence road, Sialkot, Pakistan.



## Huzaifa International solutions for dental surgeons

A craftsman is known by his tools. Today's dental surgeons are master craftsmen in their field and require precision instruments of the highest quality to perform the delicate procedures that bring **Huzaifa Intl** to thousands of faces around the world.

Smile Devotion Dental Instruments are developed to unique specifications with added features that are matched to the needs of market sectors in over 52 countries. Over 12,000 instruments, each of the finest quality, cover the entire range of general and specialized dental surgery.

With the knowledge born of 32 years of experience in the field, we are in a position to provide customized solutions, offer advice and guide you in instrument planning. We are happy to answer any query and as an innovative and reliable partner, help you solve any individual problem.

This 'Product Catalogue' provides you with technical data and information on how to order from our wide range of instruments that include Extracting Forceps, Root Elevators, Scalers, Curettes, Explorers, Excavators, Pliers, Tweezers, Impression Trays, Plastic Filling instruments and other general surgery instruments.

Please feel free to ask for any other information, other product catalogues, or any dental product not featured in this catalogue.







## Care for Dental Instruments

*“The cost of maintenance is lesser than the cost of new instruments.”*

### **The Quality, To Begin With**

Every Huzaifa International instrument passes through a system of strict quality control after each manufacturing step, guaranteeing the highest quality only. The quality control is both the inherent one and the one complying with international standards.

### **The Steel, To Be Sure**

We procure our own special steel with a higher percentage of carbon and chromium. Instruments fabricated out of this steel guarantee a longer life and durable functionality, ensuring satisfaction to users.

### **Experienced Craftsmen, To Create Master Pieces**

All instruments are crafted by hand. Be it forging, machining, grinding and sharpening, all these processes are performed by our trained and experienced craftsmen. During manufacturing, every single instrument passes through numerous steps and every step is followed by an inspection process. We do understand what depends on the high quality of our instruments and to this end we allocate our best resources.

### **Intended And Specified Use, The Long Life**

Always use the instrument for the function it has been designed for. Dental instruments are ultra fine precision instruments. A misuse can result in severe damage to the working points. Increase the life of instrument by its proper and correct use only. A pair of scissors is meant for cutting soft tissues only. It should not be used to lift bones or for exploring and scraping purpose.

### **Disinfection, Cleaning And Sterilization**

Always clean the instruments before sterilization. If the instruments are sterilized without cleaning, the stains on them can be burnt into the instruments leaving permanent marks. This is because of very high temperature during sterilization.

Before cleaning, instruments should be disinfected using a suitable disinfectant preferably the one not containing Phenol.

Manual cleaning should begin soon after the surgeries are over. Do not delay cleaning. Use a soft brush and not a steel wool or drill brush to clean the instruments to remove stubborn impurities. Instruments should always be cleaned in a non-corrosive, natural cleaning agent with little foaming. The instruments should then be rinsed in distilled water.

The use of ultrasonic cleaners and thermo-disinfectant is also becoming common. Here again, care must be taken in the selection of cleaning agents, detergents and disinfectants. Please ensure that they do not damage the metal. Always remember these methods can clean but do not sterilize!

### Some Important Care Tips:

- Before sterilization, always inspect your equipment for any dirt remains or any organic or mineral deposits. The extreme heat can cause these deposits to be permanently burnt into the instrument, increasing chances of corrosion.
- Never mix stainless steel with other metals like aluminum, brass or copper. This can cause electrochemical changes and also produce etching or staining.
- Use distilled or demineralized water only.
- Always follow the manufacturer's instructions precisely when it comes to the temperatures and times involved for autoclaving, dry heating or germicidal solvents.
- Dry each instrument separately and completely. In case of remaining moisture, dry using a sterile cloth.
- Always use physiological oil and other suitable lubricants to keep instruments well oiled. This is especially required for instruments comprising many parts like scissors, pliers and gouges. A regular use of oil prevents stiffness and corrosion and results in smooth functioning.
- Hinged instruments like forceps and needle holders should always be opened for cleaning and sterilization.
- Etching or engraving instruments for personal identification can damage the instrument itself and cause damage to other instruments as well. Damage to the polished surface can always lead to corrosion.
- Although stainless steel has outstanding corrosion resistant properties, contact with certain chemicals must be avoided.





# Table of Contents

<b>Chapter 1</b>	<b>01</b>	<p><b>Dental Extraction Forceps</b> Zahnzangen Forceps de extracción Daviers Pinze per estrazioni</p> <p><b>English Pattern</b> Englische Form Forma inglesa Forme anglaise Forma inglese</p>
<b>Chapter 2</b>	<b>11</b>	<p><b>Dental Extraction Forceps</b> Zahnzangen Forceps de extracción Daviers Pinze per estrazioni</p> <p><b>With Alpha Handle</b> Mit Alfa-Griff Con mango Alfa Manche Alfa</p>
<b>Chapter 3</b>	<b>12</b>	<p><b>Dental Extraction Forceps</b> Zahnzangen Forceps de extracción Daviers Pinze per estrazioni</p> <p><b>For children</b> Kinderzahnzangen Para niños Pour enfants Per bambini</p>
<b>Chapter 4</b>	<b>16</b>	<p><b>Dental Extraction Forceps</b> Zahnzangen Forceps de extracción Daviers Pinze per estrazioni</p> <p><b>American Pattern</b> Amerikanische form Forma americana Forme américaine Forma americana</p>
<b>Chapter 5</b>	<b>25</b>	<p><b>Root Elevators</b> Wurzelheber Elevadores para raíces Elévateurs à racines Leve per radici</p>
<b>Chapter 6</b>	<b>33</b>	<p><b>Amalgam Instruments</b> Amalgaminstrumente Instrumentos para amalgama Instruments à amalgame Strumenti per amalgma</p>
<b>Chapter 7</b>	<b>45</b>	<p><b>Scalers, Curettes</b> Zahnreiniger, Küretten Limpiadores de sarro, Curetas Instruments à détartrer, Curettes Scaler, Curette</p>
<b>Chapter 8</b>	<b>49</b>	<p><b>Periodontia Instruments</b> Instrumente Zur paradontologie Instrumentos para periodoncia Instruments pour la parodontologie Strumenti per parodontologia</p>
<b>Chapter 9</b>	<b>57</b>	<p><b>Excavators, Probes &amp; Explorers, Nerve instruments</b> Exkavatoren, Zahnsonden, Nervinstrumente Excavadores, sondas y exploradores Instrumentos para nervios Excavateurs, Sondes, et explorateurs Escavatori, Sonde, Strumenti per nervi</p>
<b>Chapter 10</b>	<b>67</b>	<p><b>Wax and Crown Instruments, Matrix Instruments</b> Wachs-kroneninstrumente, Matrizen-instrumente Instrumentos para cera, coronas, instrumentos para matrices Instruments pour couronnes et matrices Strumenti per cera e per corone</p>

<b>Chapter 11</b>	<b>75</b>	<b>Chapter 17</b>	<b>109</b>
<b>Impression Trays</b> Abdrucklöffler Portamoldes Porte-empreintes Porta-impronte		<b>Retractor</b> Wundhaken Separadores Ecarteurs Retrattori	
<b>Chapter 12</b>	<b>87</b>	<b>Chapter 18</b>	<b>112</b>
<b>Pliers For Orthodontics</b> Zangen für Kieferorthopädie Pinzas para orthodoncia Pinces pour orthodoontie Pinze per Ortodonzia		<b>Bone Cutting Forceps, Bone Rongeurs</b> Hohlemeißelzangen, Knochen Splitterzangen Pinzas Cortentes para huesos Pinces à os coupantes, Pinces-gouges Scalpellini e pinze alveolotome	
<b>Chapter 13</b>	<b>97</b>	<b>Tongue Depressors, Mouth Gags</b> Zungenspatel, Mundsperrer Bajalenguas, Abrebocas Abaisse-langues, Ouvre-bouches Spatola per lingu, a Abribocca	
<b>Knives, Scalpels</b> Messer, Skalpelle Bisturís Bistouris Bisturi		<b>Bone Chisels, Currettes</b> Flachmeißel, Scharfe Löffel Cinceles, Cucharillas Cortantes Ciseaux-burins, Currettes tranchantes ScalPELLI, Cucchiaini per osso	
<b>Chapter 14</b>	<b>99</b>	<b>Chapter 19</b>	<b>119</b>
<b>Scissors</b> Scheren Tijeras Ciseaux Forbici		<b>Sterilization, Asepsis</b> Sterilisation, Asepsis Esterilización, Asepsia Stérilisation, Asepsis Sterilizzazione, Asepsi	
<b>Chapter 15</b>	<b>102</b>	<b>Chapter 20</b>	<b>125</b>
<b>Forceps</b> Pinzetten Pinzas Pinces Pinzette		<b>Surgery</b> Chirurgie Chirguia Chirurgie Chirurgia	
<b>Hemostatic Forceps</b> Arterienklemmen Pinzas hemostaticas Pinces hémostatiques Pinze emostatiche		<b>Chapter 21</b>	<b>131</b>
<b>Chapter 16</b>	<b>107</b>	<b>Dental instruments sets</b> Satz Instrumente Sistema de instrumentos Ensemble d' instruments Insieme degli strumenti	
<b>Needle holders</b> Nadel halter Portaagujas Porte-aiguilles Porta aghi			



## CH 01-04

- CH 01** English Pattern  
Englische Form  
Forma inglesa  
Forma anglaise  
Forma inglese
- CH 02** With Alpha Handle  
Mit Alfa-Griff  
Con mango Alfa  
Manche Alfa  
Maniglia dell'alfa
- CH 03** For children  
Kinderzahnzangen  
Para niños  
Pour enfants  
Per bambini
- CH 04** American Pattern  
Amerikanische form  
Forma americana  
Forme américaine  
Forma americana

**Dental Extraction Forceps**  
Forceps de extracción  
Zahnzangen  
Daviers  
Pinze per estrazioni



All Extracting Dental Forceps are also available in **Non-Slip Grip Jaws**.  
 Please see page 11 for ordering details.



**HI- 01-0101**  
Fig.1



**HI- 01-0102**  
Fig.2



**HI- 01-0103**  
Fig.3



**HI- 01-0104**  
Fig.4

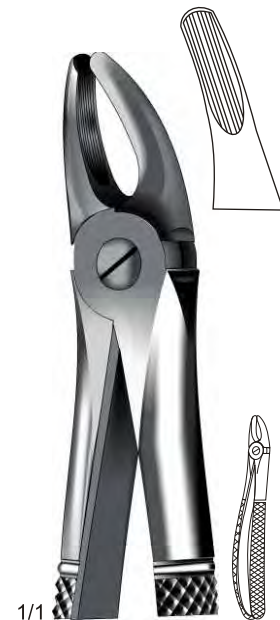

**HI- 01-0107**  
Fig.7



**HI- 01-0108**  
Fig.8



**HI- 01-0113**  
Fig.13





**HI- 01-0117**  
Fig. 17



**HI- 01-0118**  
Fig. 18



**HI- 01-0218**  
Fig. 18 A



**HI- 01-0219**  
Fig. 19



**HI- 01-0220**  
Fig. 20



**HI- 01-0221**  
Fig. 21



**HI- 01-0222**  
Fig. 22

All Extracting Dental Forceps are also available in **Non-Slip Grip Jaws**.  
 Please see page 11 for ordering details.



**HI- 01-0223**  
Fig. 23



**HI- 01-0224**  
Fig. 24



**HI- 01-0229**  
Fig. 29



**HI- 01-0329**  
Fig. 29 N



**HI- 01-0330**  
Fig. 30



**HI- 01-0331**  
Fig. 31



**HI- 01-0333**  
Fig. 33



**HI- 01-0433**  
Fig. 33 A





**HI- 01-0533**  
Fig. 33 C



**HI- 01-0633**  
Fig. 33 M



**HI- 01-0641**  
Fig. 41



**HI- 01-0644**  
Fig. 44



**HI- 01-0645**  
Fig. 45

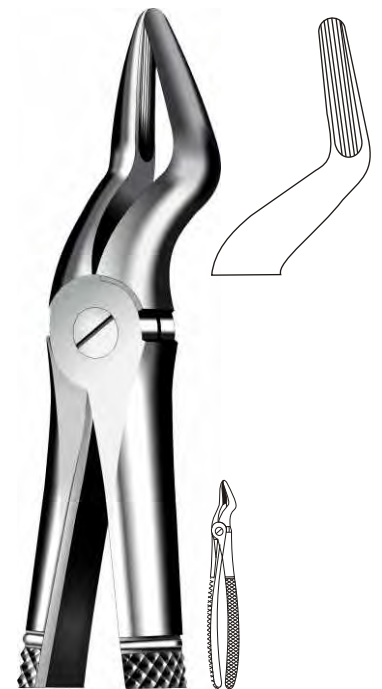

**HI- 01-0651**  
Fig. 51

All Extracting Dental Forceps are also available in **Non-Slip Grip Jaws**.  
 Please see page 11 for ordering details.

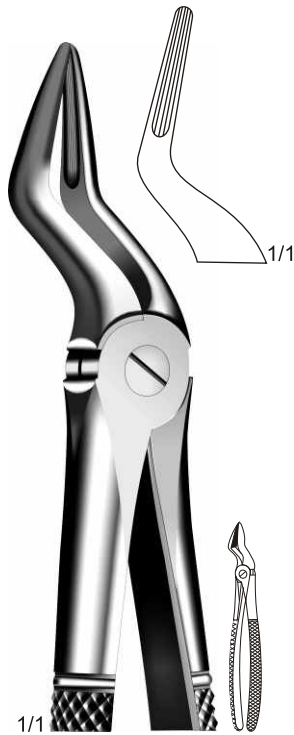

**HI- 01-0751**  
Fig. 51 A

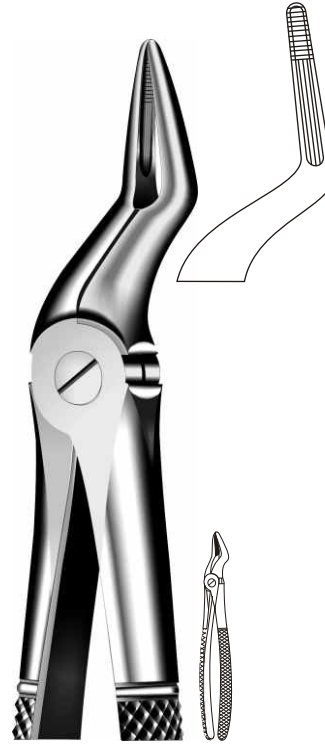

**HI- 01-0851**  
Fig. 51 C

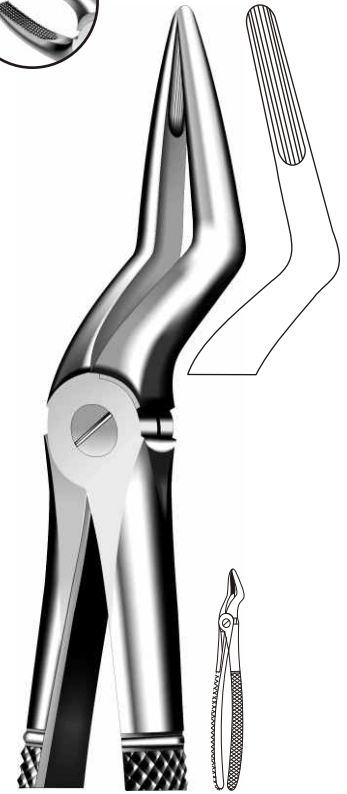

**Mod. Pro**  
**HI- 01-0951**  
Fig. 51 M

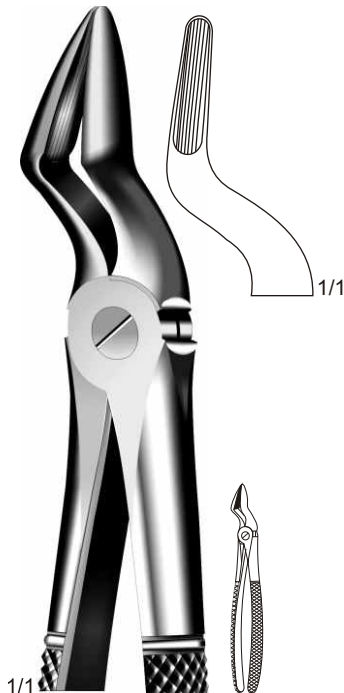

**HI- 01-0952**  
Fig. 52

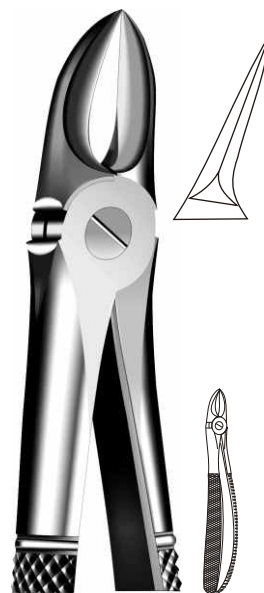

**HI- 01-0955**  
Fig. 55

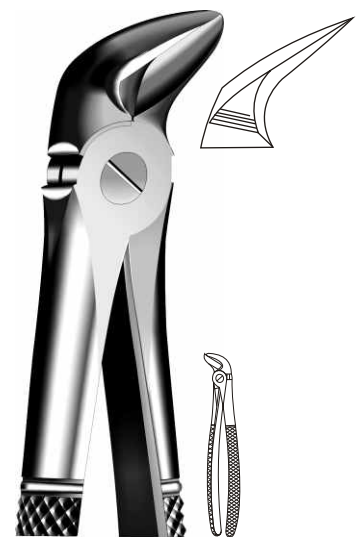

**HI- 01-0956**  
Fig. 56

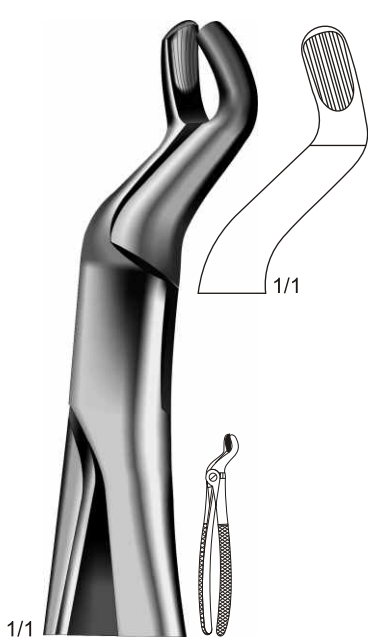

**HI- 01-0967**  
Fig. 67

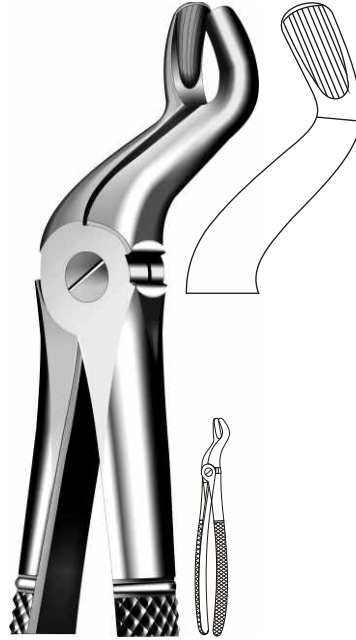

**HI- 01-1067**  
Fig. 67 A



**HI- 01-1073**  
Fig. 73

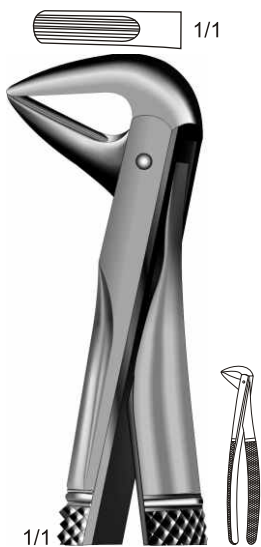

**HI- 01-1074**  
Fig. 74



**HI- 01-1174**  
Fig. 74 M



**HI- 01-1274**  
Fig. 74 N



**HI- 01-1275**  
Fig. 75



All Extracting Dental Forceps are also available in **Non-Slip Grip Jaws**.  
 Please see page 11 for ordering details.

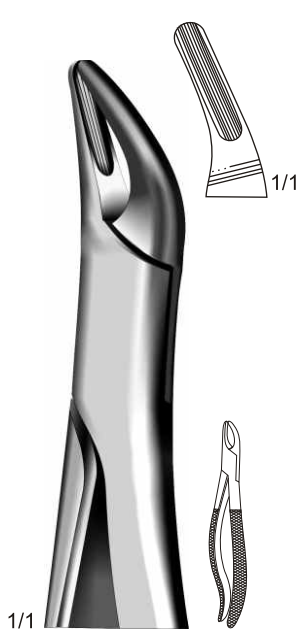

1/1  
 Lowrence Read  
**HI- 01-1276**  
 Fig. 76

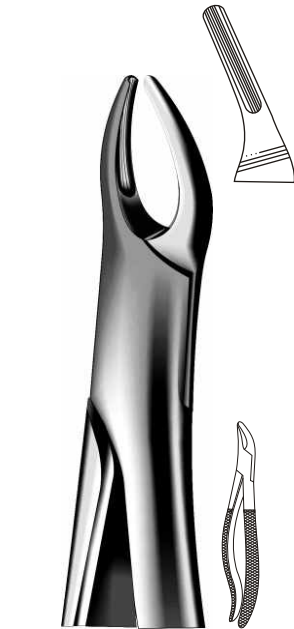

Lowrence Read  
**HI- 01-1376**  
 Fig. 76 N



**HI- 01-1379**  
 Fig. 79



**HI- 01-1479**  
 Fig. 79 A



1/1  
**HI- 01-1486**  
 Fig. 86 A



**HI- 01-1586**  
 Fig. 86 B



**HI- 01-1686**  
 Fig. 86 C

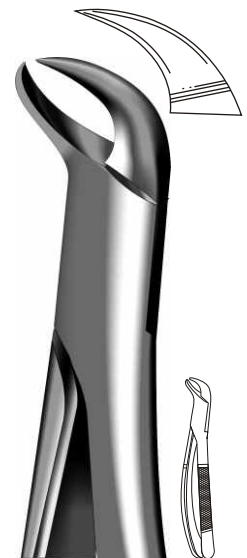

**HI- 01-1687**  
 Fig. 87

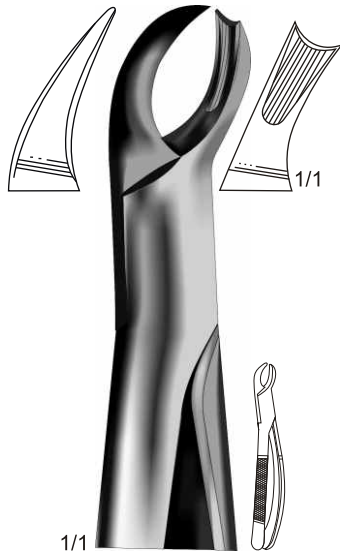

**HI- 01-1689**  
Fig. 89

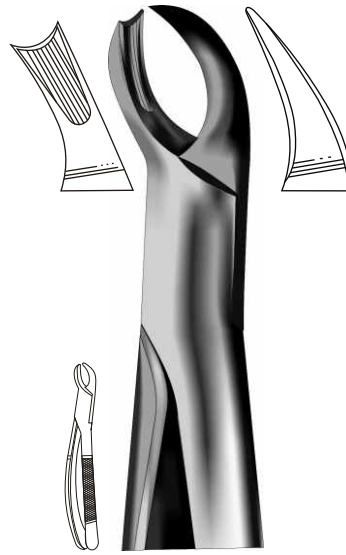

**HI- 01-1690**  
Fig. 90

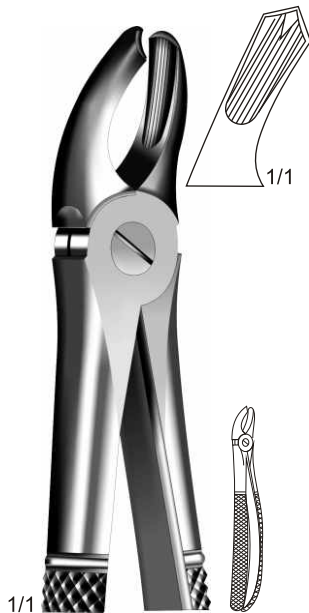

**HI- 01-1694**  
Fig. 94

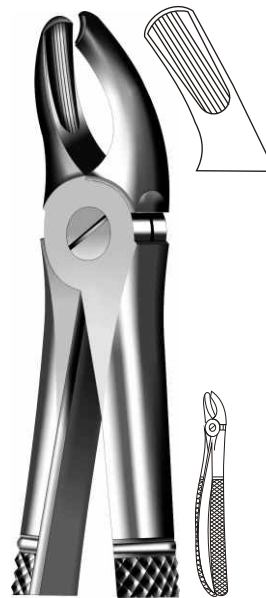

**HI- 01-1695**  
Fig. 95



**HI- 01-1699**  
Fig. 99

All Extracting Dental Forceps are also available in **Non-Slip Grip Jaws**.  
 Please see page next for ordering details.

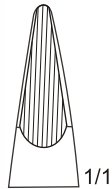

1/1  
**Mead**  
**HI- 01-1701**  
 Fig. MD 1

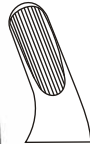

**Mead**  
**HI- 01-1702**  
 Fig. MD 2

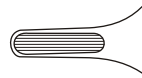

**Mead**  
**HI- 01-1703**  
 Fig. MD 3

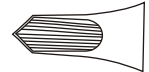

**Mead**  
**HI- 01-1704**  
 Fig. MD 4



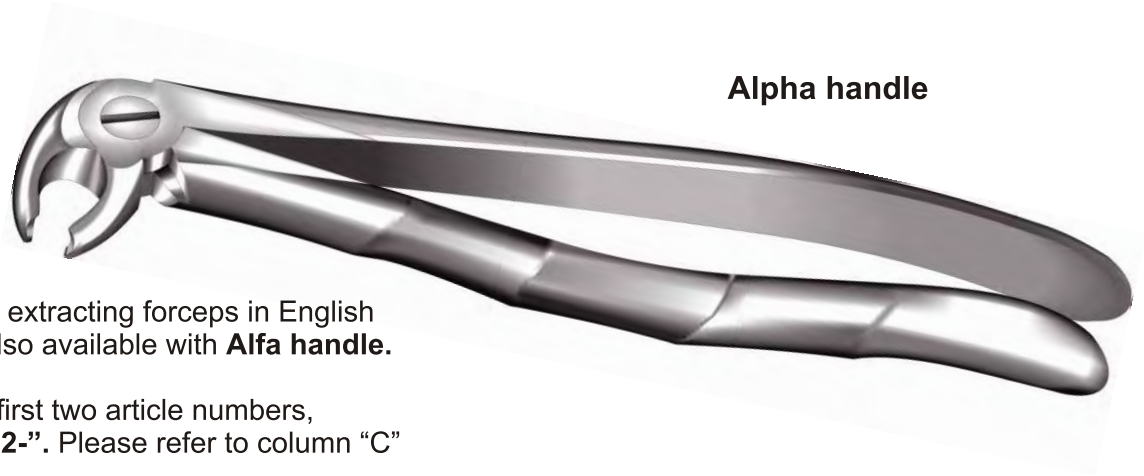

All preceding extracting forceps in English pattern are also available with **Alfa handle**.

Just replace first two article numbers, “01-” with “02-”. Please refer to column “C” below.

### Non-Slip Grip Jaws



All preceding extracting forceps in English pattern are also available in **Non-Slip Grip Jaws**.

Please add “NS” with existing article numbers. e.g HI- 01-0101NS. Please refer to column B.

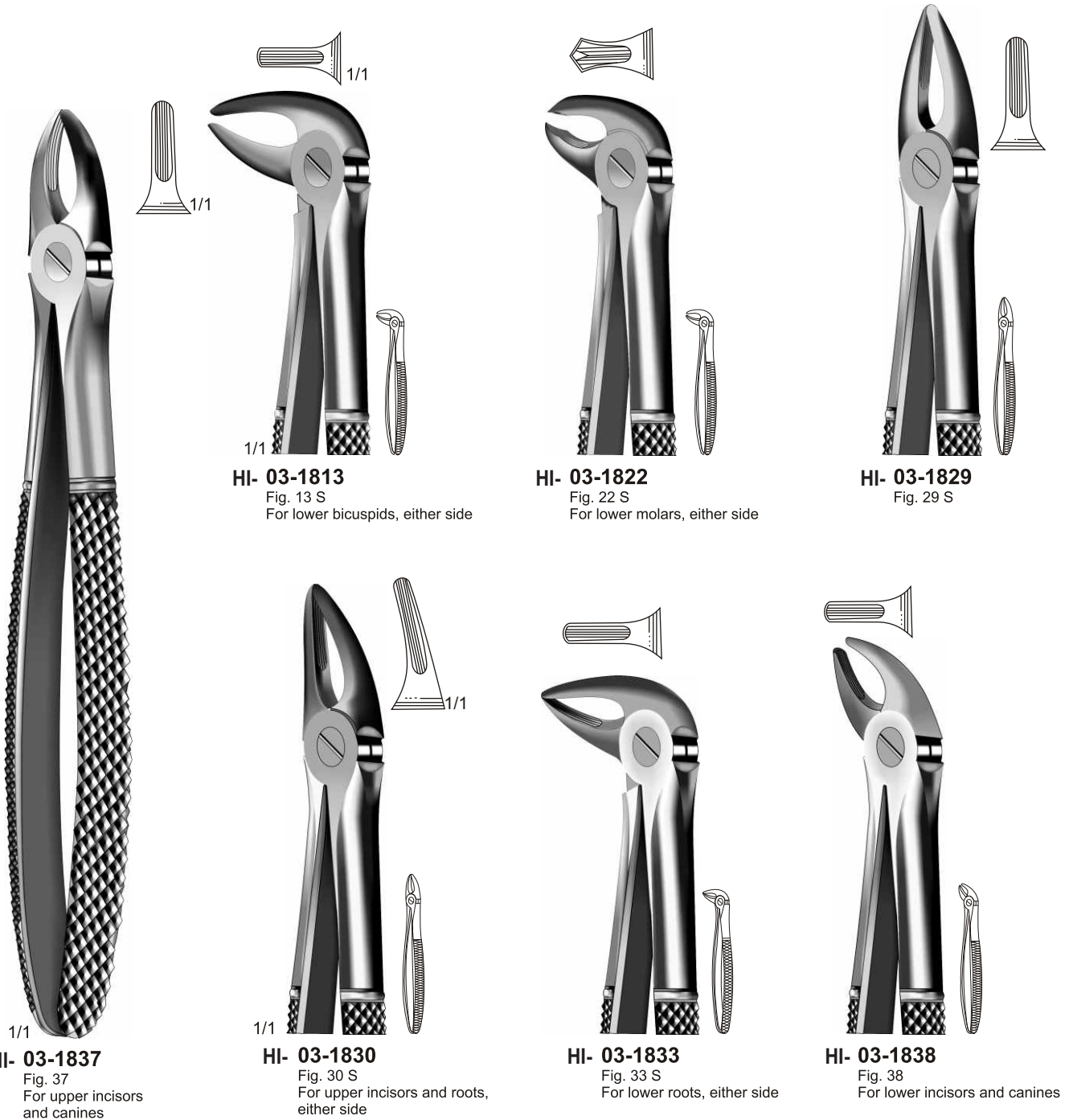

**HI- 03-1813**  
 Fig. 13 S  
 For lower bicuspsids, either side

**HI- 03-1822**  
 Fig. 22 S  
 For lower molars, either side

**HI- 03-1829**  
 Fig. 29 S

**HI- 03-1837**  
 Fig. 37  
 For upper incisors  
 and canines

**HI- 03-1830**  
 Fig. 30 S  
 For upper incisors and roots,  
 either side

**HI- 03-1833**  
 Fig. 33 S  
 For lower roots, either side

**HI- 03-1838**  
 Fig. 38  
 For lower incisors and canines



**HI- 03-1839**  
 Fig. 39  
 For upper molars, either side



**HI- 03-1939**  
 Fig. 39 A  
 For upper molars, either side



**HI- 03-2039**  
 Fig. 39 L  
 For left upper molar



**03-1810**



**HI- 03-2139**  
 Fig. 39 R  
 For right upper molar



**HI- 03-2140**  
 Fig. 40  
 For lower molars, either side



**HI- 03-2151**  
 Fig. 51 S  
 For upper roots, either side





**Klein**  
**HI- 03-2203**  
 Fig. 3  
 For upper molars

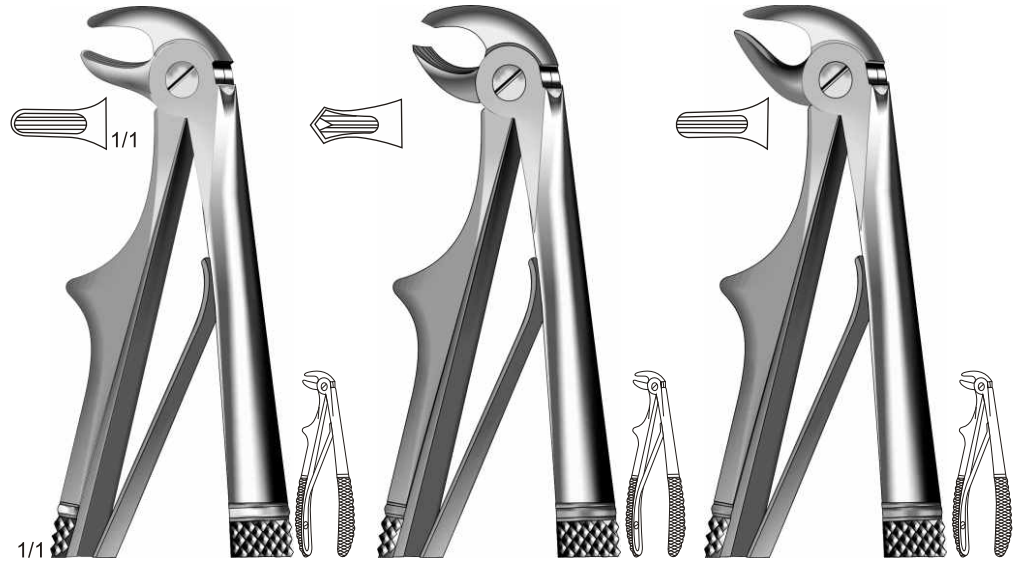

**Klein**  
**HI- 03-2205**  
 Fig. 5  
 For lower incisors

**Klein**  
**HI- 03-2206**  
 Fig. 6  
 For lower molars

**Klein**  
**HI- 03-2207**  
 Fig. 7  
 For lower roots



**Klein**  
**HI- 03-3137**  
 Fig. 137  
 For upper incisors & canines



**Klein**  
**HI- 03-3139**  
 Fig. 139  
 For upper bicusps



**Klein**  
**HI- 03-3151**  
 Fig. 51 S  
 For upper roots

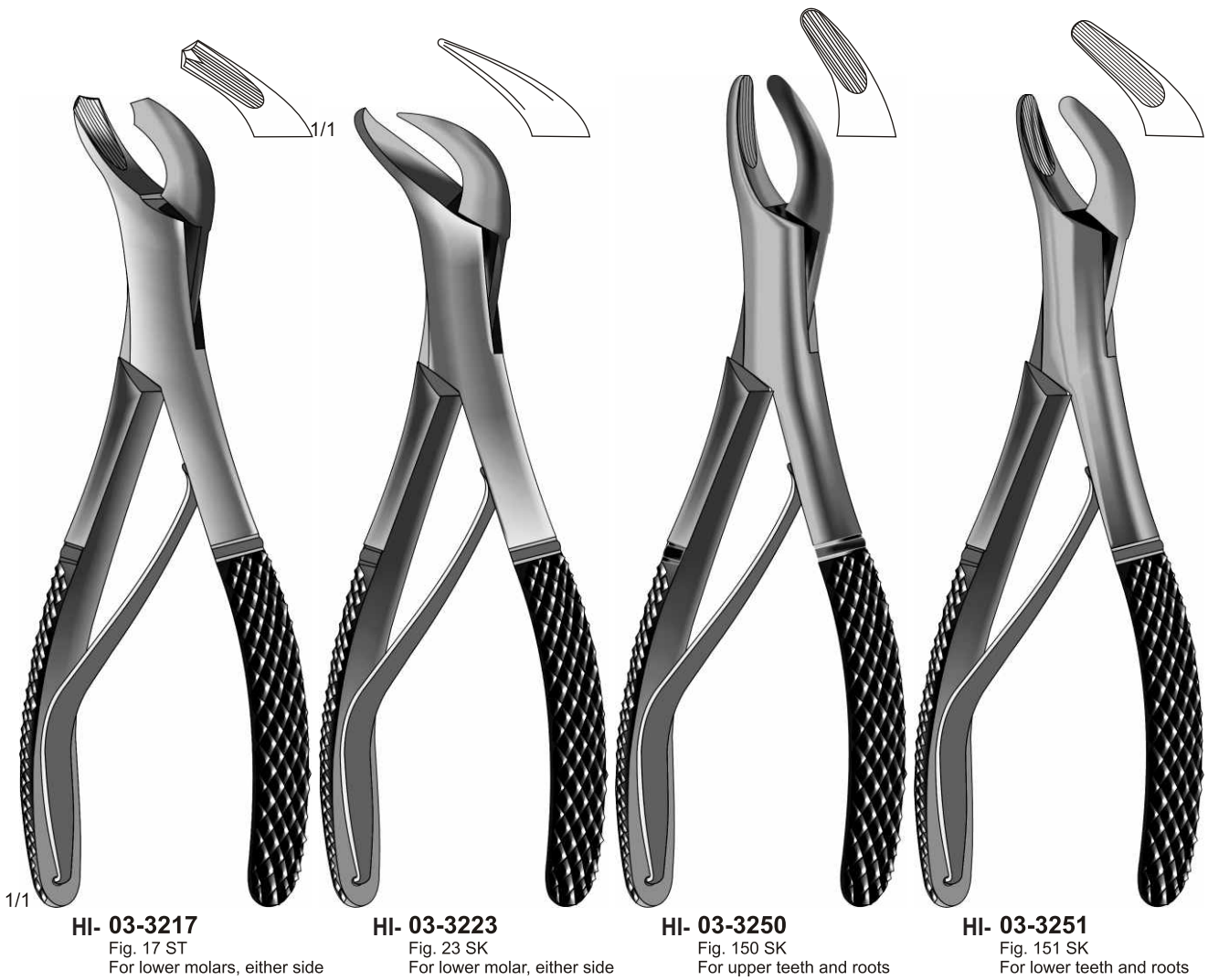





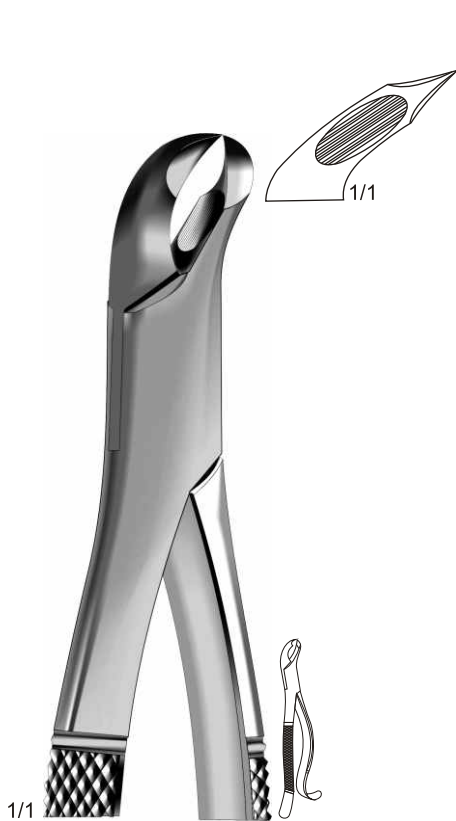

**Woodward**  
**HI- 04-0203**  
 Fig. 3 FH  
 For lower molars



**HI-04-0310 HI-04-0410**  
 Fig. 10 H / Fig. 10 S  
 For upper molars, either side

**HI- 04-0310**  
 Fig. 10 H

**HI- 04-0410**  
 Fig. 10 S



**Harris**  
**HI- 04-0415**  
 Fig. 15

**HI- 04-0416**  
 Fig. 16  
 For lower molars

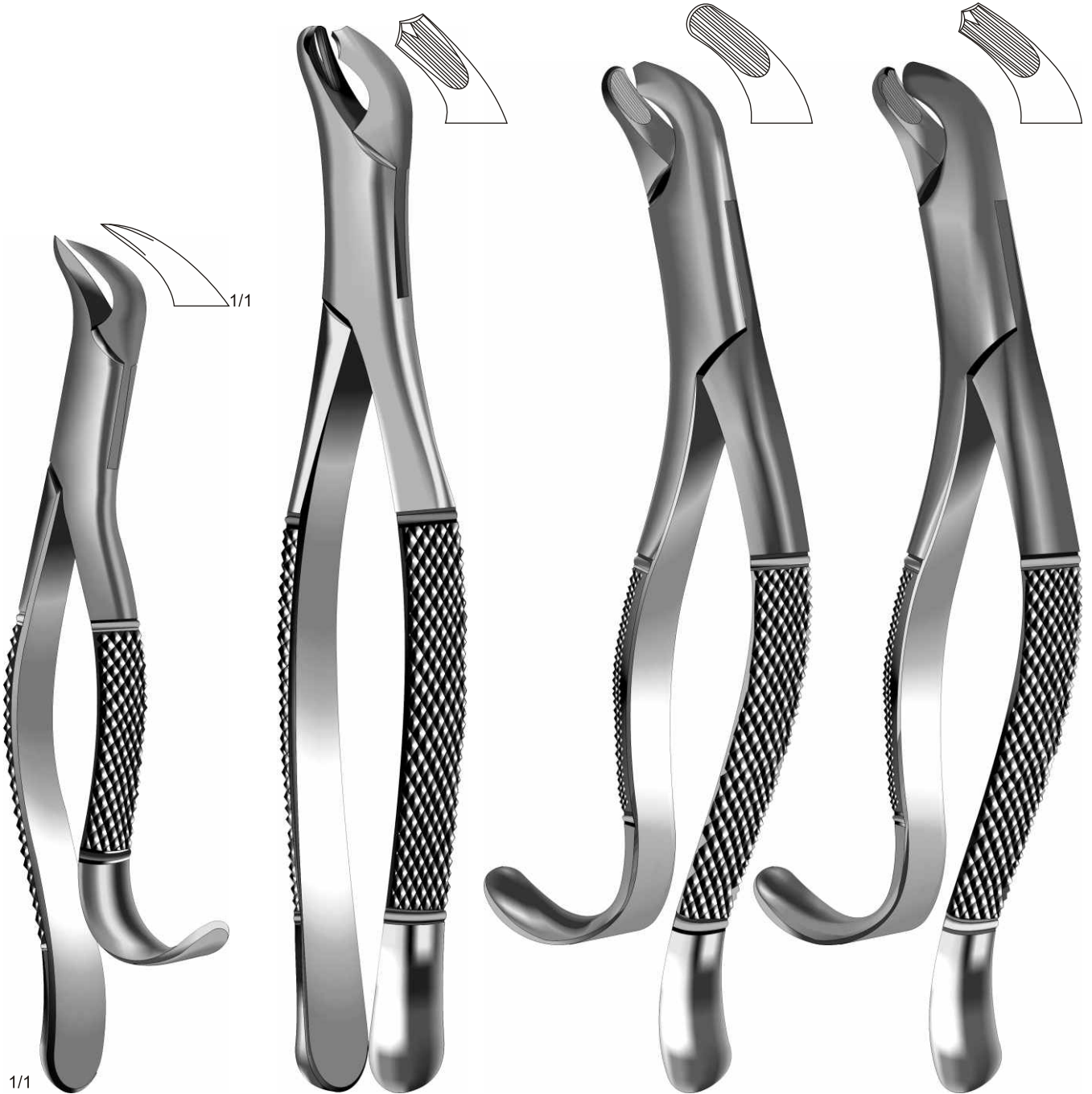

1/1

**HI- 04-0516**  
Fig .16 S

**HI- 04-0517**  
Fig .17

**Harris**  
**HI- 04-0618**  
Fig .18 L

**Harris**  
**HI- 04-0718**  
Fig .18 R



**HI- 04-0723**  
Fig. 23  
For lower molars, either side

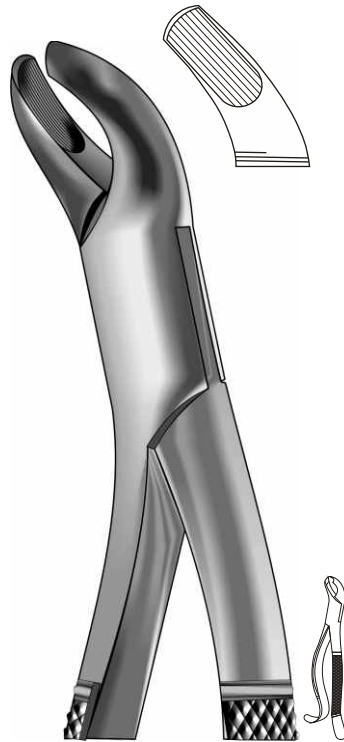

**HI- 04-0724**  
Fig. 24  
For upper molars, either side

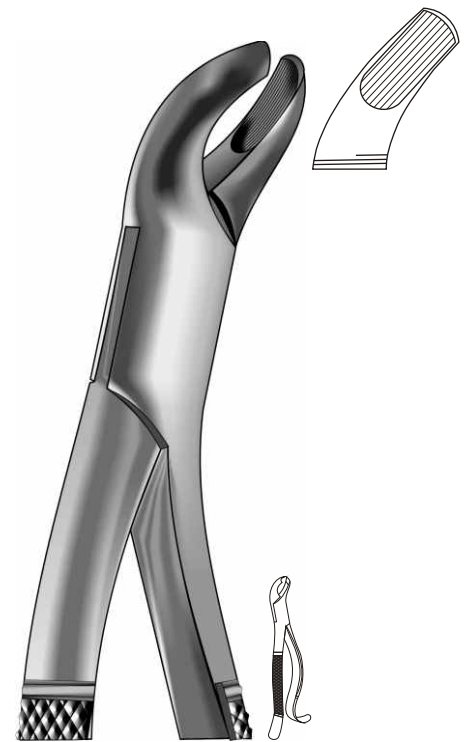

**HI- 04-0727**  
Fig. 27

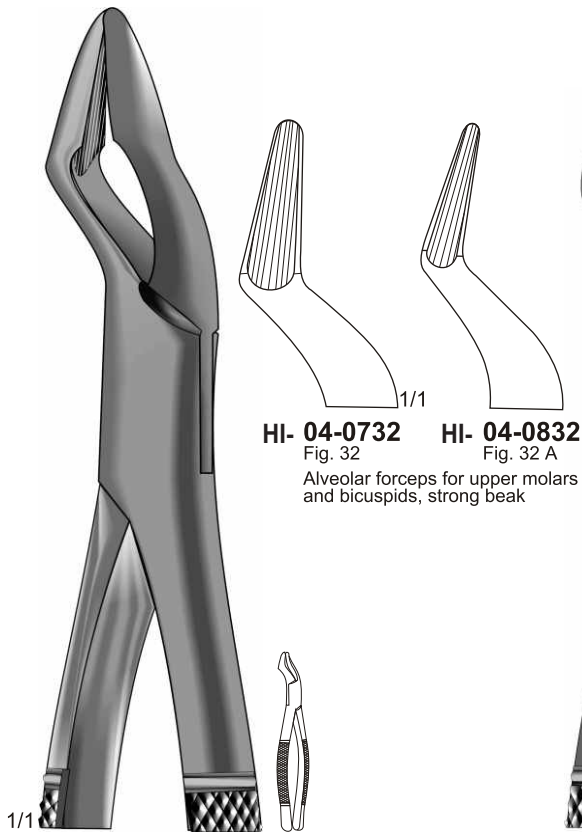

**HI- 04-0732** Fig. 32  
**HI- 04-0832** Fig. 32 A  
Alveolar forceps for upper molars and bicuspid, strong beak

Parmly  
**HI-04-0732 - HI-04-0832**



**HI- 04-0853**  
Fig. 53 L  
For upper molars left side



**HI- 04-0953**  
Fig. 53 R  
For upper molars right side



**HI- 04-0962**  
 Fig. 62  
 Universal forceps for upper  
 teeth & roots, also for children

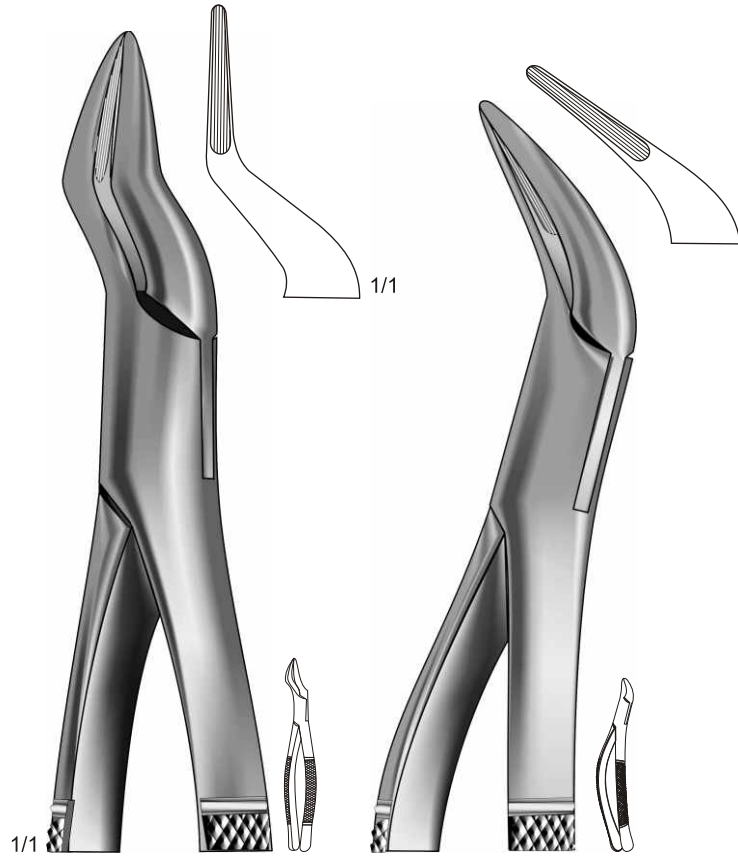

**HI- 04-0965**  
 Fig. 65  
 For upper incisors  
 and roots, long  
 slender beak

**Tomes**  
**HI- 04-0969**  
 Fig. 69  
 For fragments and  
 small roots upper & lower





**Hull**  
**HI- 04-1101**  
Fig .101  
Universal forceps for  
bicuspid and milk teeth

**HI- 04-1103**  
Fig .103  
For lower bicuspid  
incisors, roots, either side

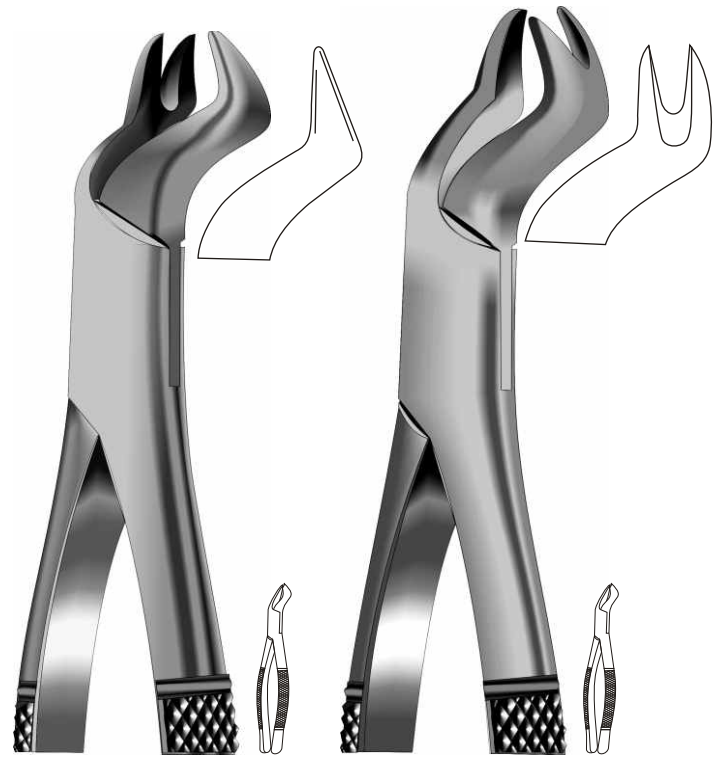

**Nevius**  
**HI- 04-1188**  
Fig .88 L  
For left upper molar

**Nevius**  
**HI- 04-1288**  
Fig .88 R  
For right upper molar



**Kells**  
**HI- 04-1299**  
 Fig .99 A  
 For upper bicuspids,  
 cuspids and incisors



**Kells**  
**HI- 04-1399**  
 Fig .99 C  
 For upper bicuspids,  
 cuspids and incisors



**Nevius**  
**HI- 04-2110**  
 Fig .110  
 For upper cuspids and bicuspids



**Nevius**  
**HI- 04-3110**  
 Fig .110  
 For upper cuspids and bicuspids



**Cryer**  
**HI- 04-4150**  
 Fig. 150



**Cryer**  
**HI- 04-5150**  
 Fig. 150 A



**Cryer**  
**HI- 04-6150**  
 Fig. 150 S



**Cryer**  
**HI- 04-6151**  
 Fig. 151



**Cryer**  
**HI- 04-7151**  
 Fig. 151 A



**Cryer**  
**HI- 04-8151**  
 Fig. 151 S

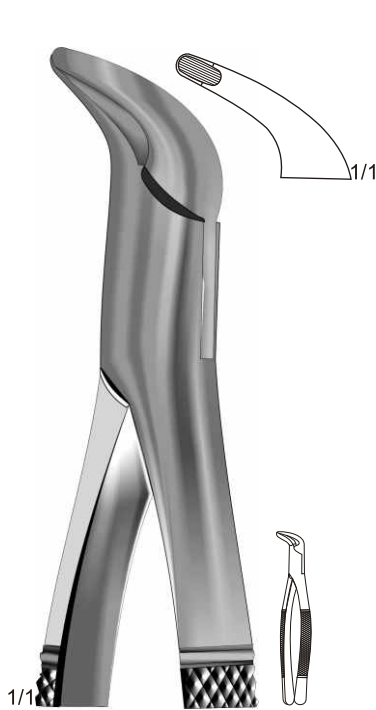

**HI- 04-8203**  
Fig. 203

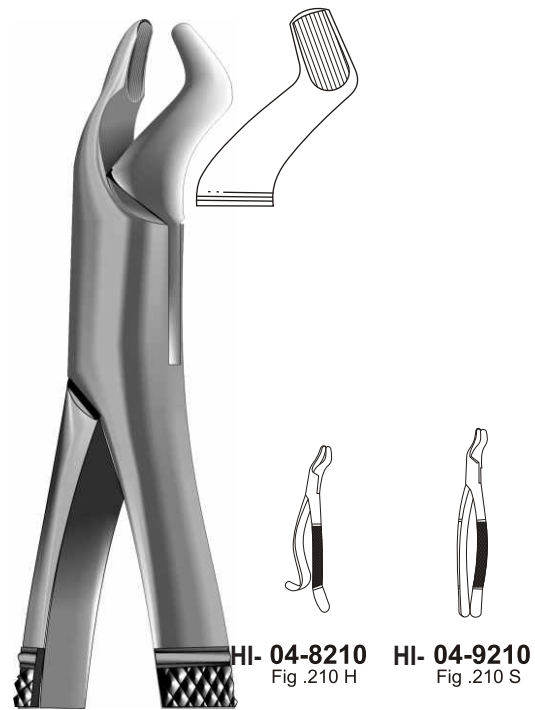

**HI- 04-8210 - 04-9210**

**HI- 04-8210**  
Fig. .210 H

**HI- 04-9210**  
Fig. .210 S

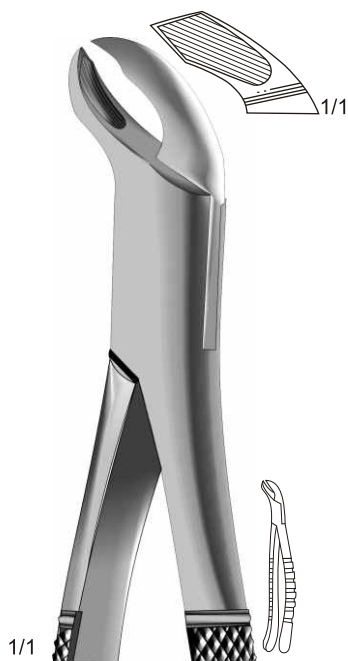

**HI- 04-9217**  
Fig. .217

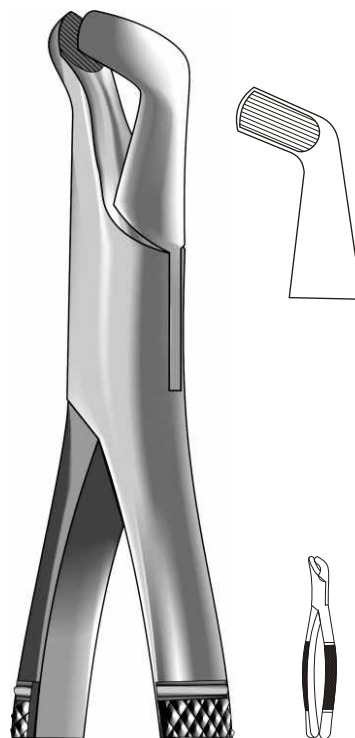

**HI- 04-9222**  
Fig. .222

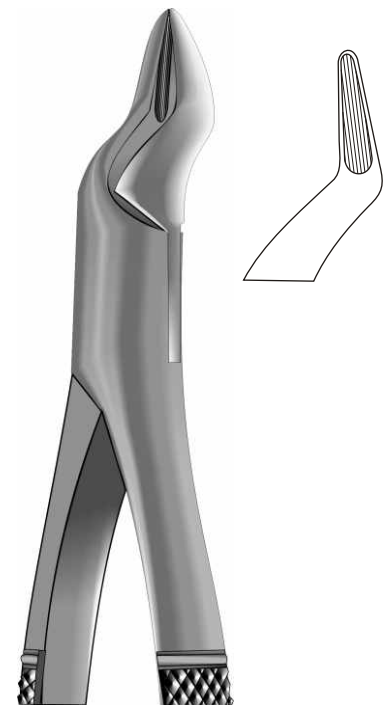

**HI- 04-9286**  
Fig. .286



# CH 05

Root Elevators  
Wurzelheber  
Elevadores para raíces  
Élévateurs à racines  
Leve per radici



## Choice of Handles for Root Elevators.

If you wish to order a different type (**A, B, C, D, E, F and G**) of handle for a particular product, please mention **that** type with the code number of that product.

**Example :** HI-05-0701E

If you wish to order a particular type (**A, B, C, D, E, F and G**) of handle with all instruments, please mention **that** type in your purchase order.

**Example :** Please use handle **C** for all **Scalers**.



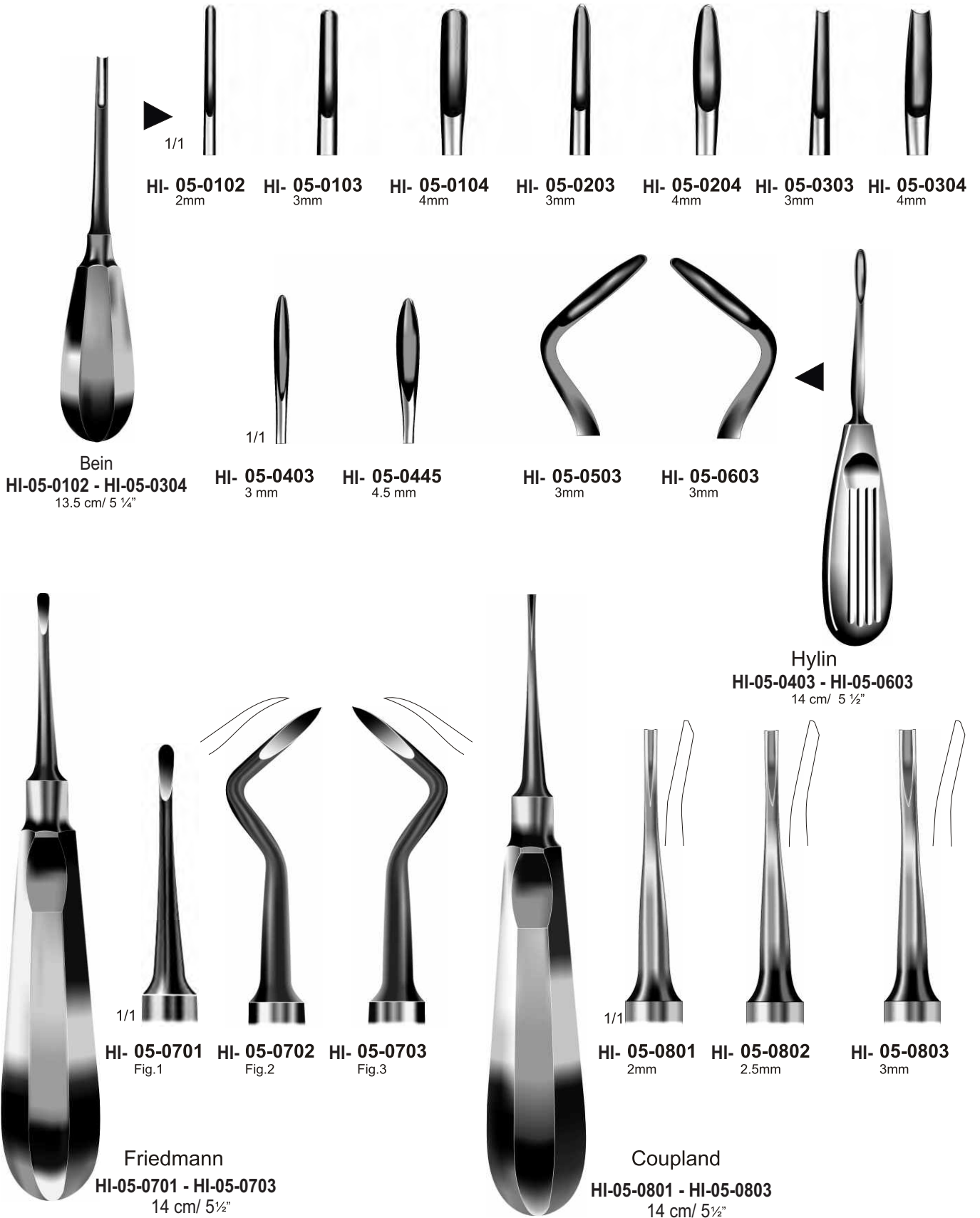

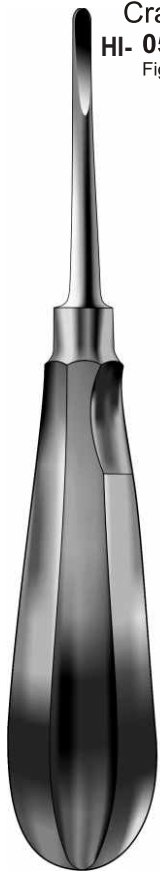
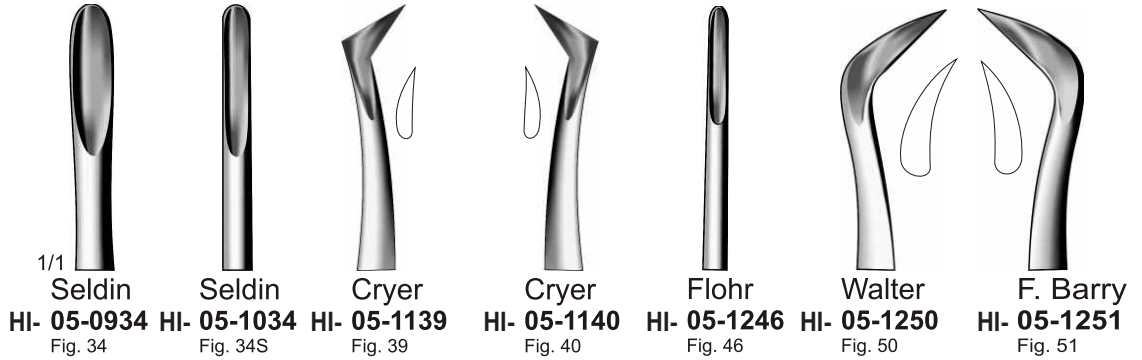

HI-05-0934 - HI-05-2304  
13.5cm/ 5 1/4"

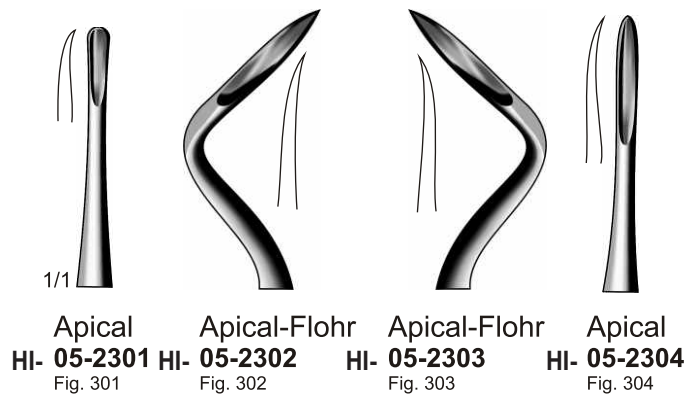
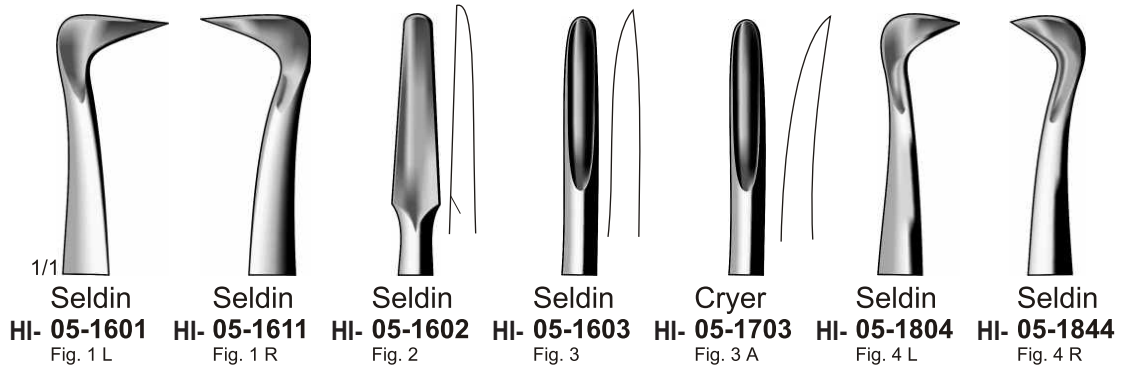



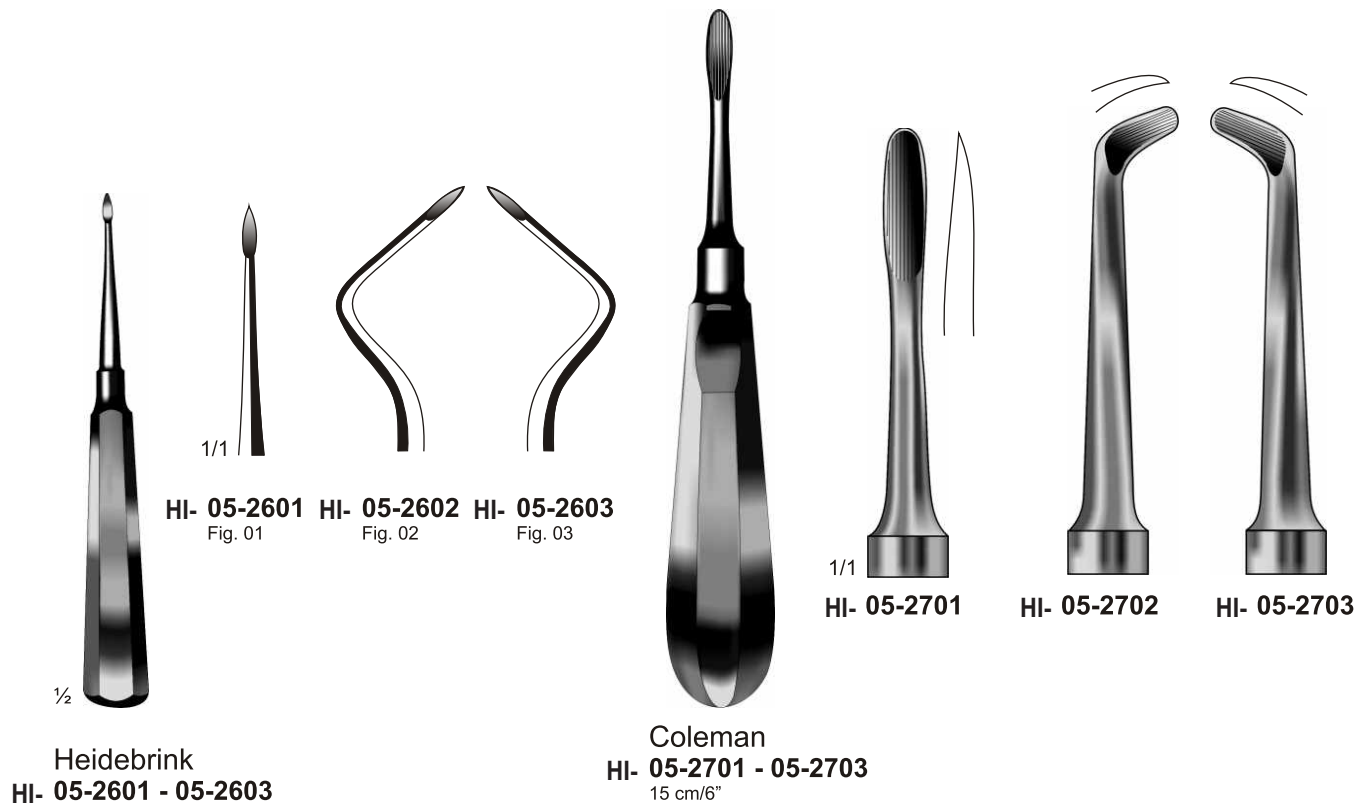
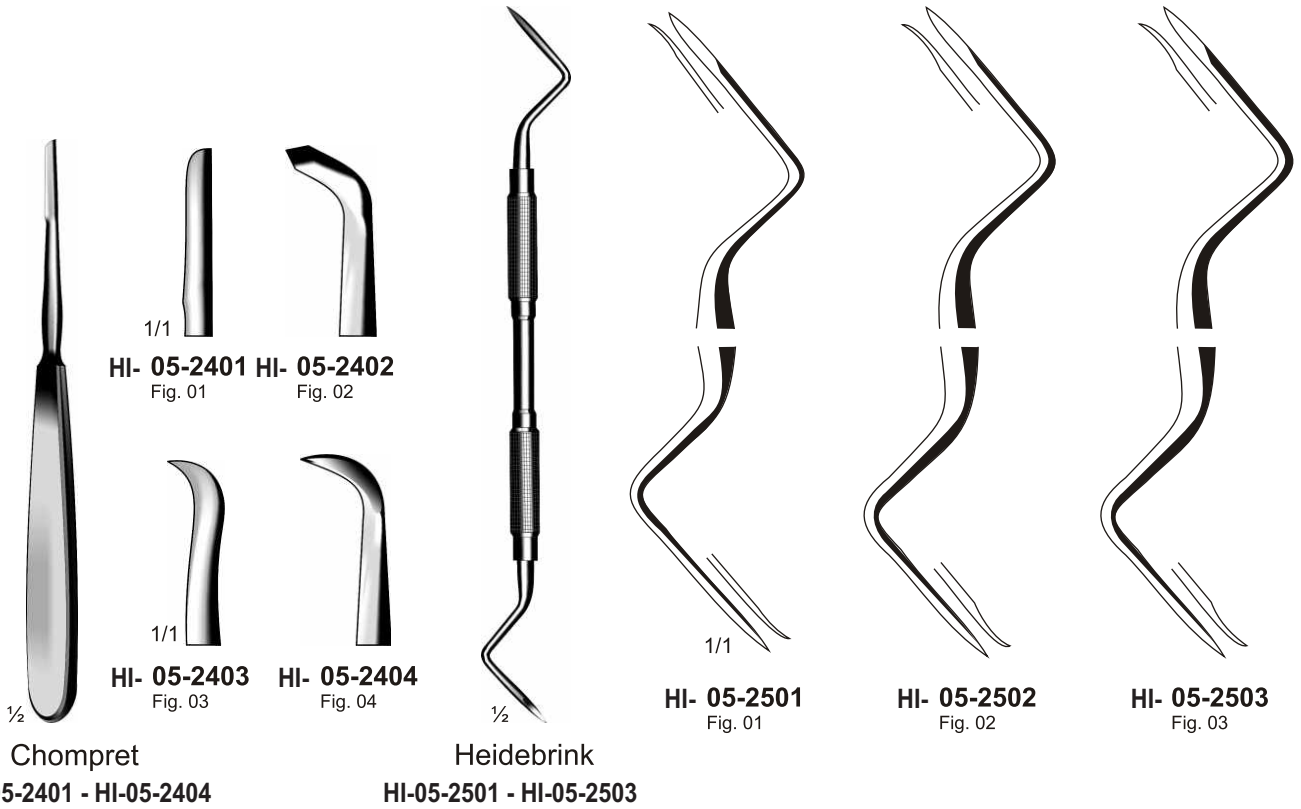

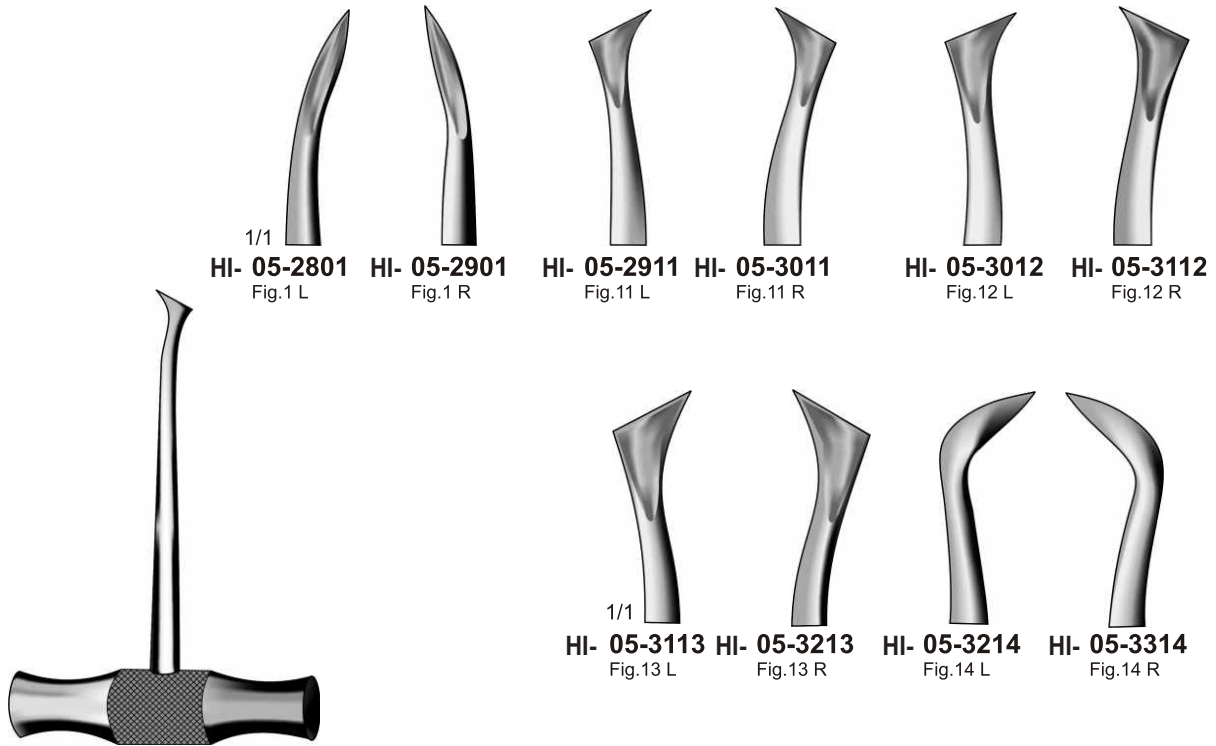

Winter

HI-05-2801 - HI-05-3314

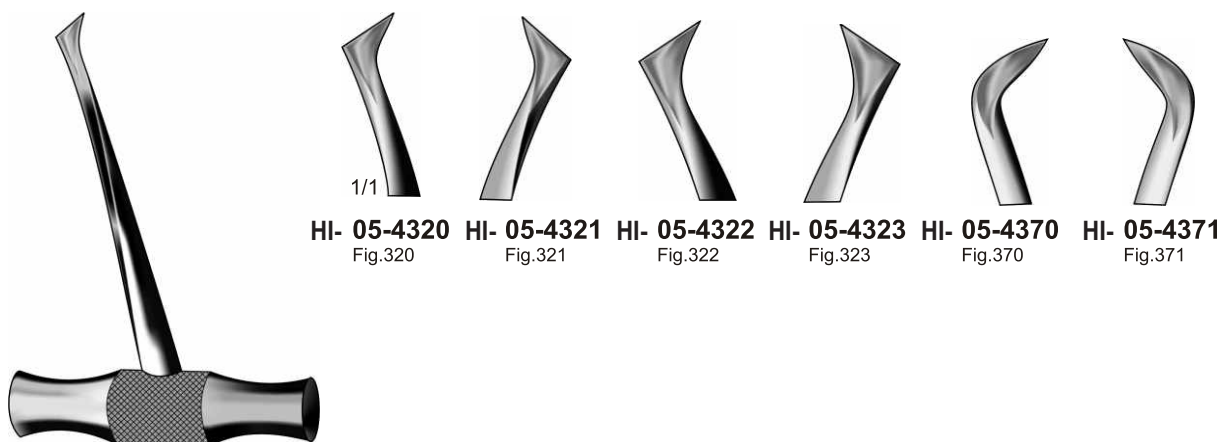

Walter F. Barry

HI-05-4320 - HI-05-4371



Fig. 1

Krallengnber  
HI- 05-4401

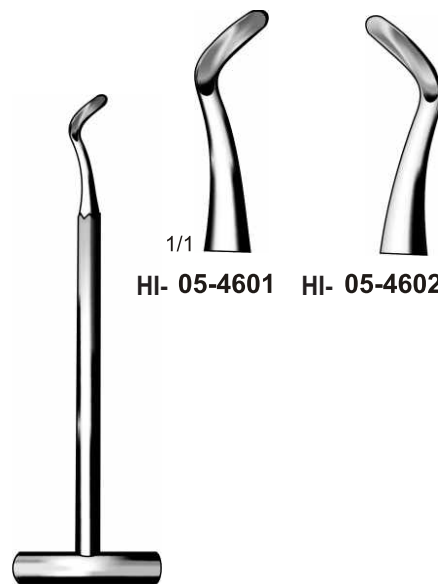

Fig. 2

Krallengnber  
HI- 05-4402



Lecluse  
HI- 05-4501



1/1  
HI- 05-4601 HI- 05-4602

Pott  
HI-05-4604 - HI-05-4602

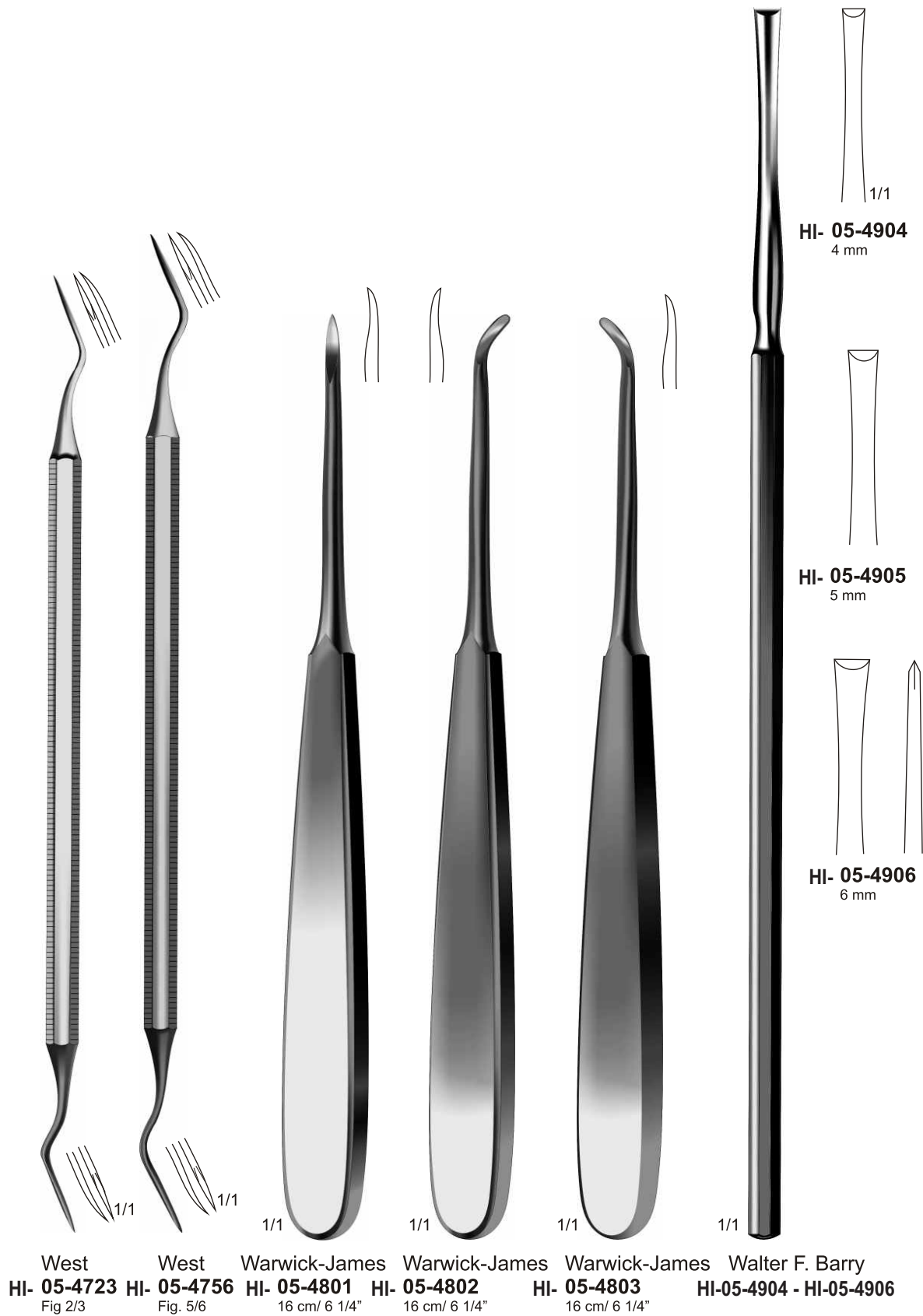



## CH 06

**Amalgam Instruments**  
**Amalgaminstrumente**  
**Instrumentos para amalgama**  
**Instrumente à amalgame**  
**Strumenti per amalgma**



**Choice of Handles for Scalers, Amalgam Instruments, Filling Instruments, Curettes, Probes, Knives, Explorers and Excavators**

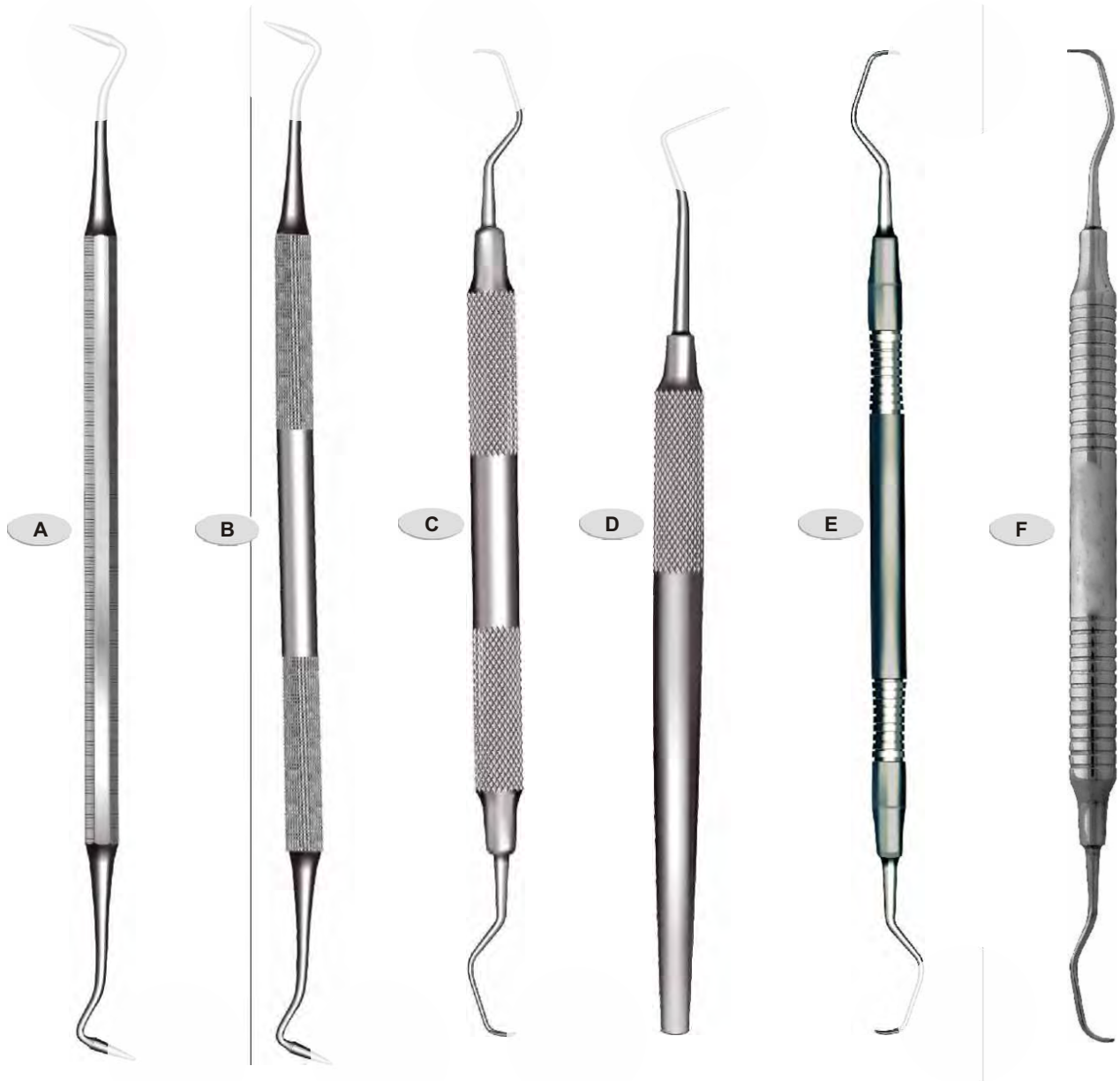

If you wish to order a different type (**A, B, C, D, E and F**) of handle for a particular products, please mention **that** type with the code number of that product.

**Example : HI-06-1001C**

If you wish to order a particular type (**A, B, C, D, E and F**) of handle with all instruments, please mention **that** type in your purchase order.

**Example : Please use handle C for all Scalers.**

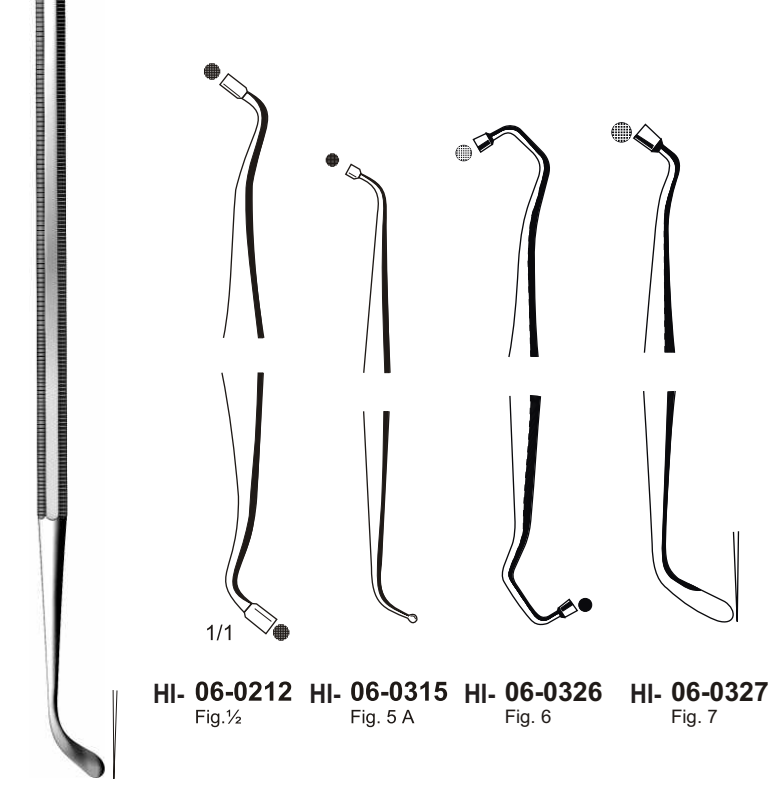
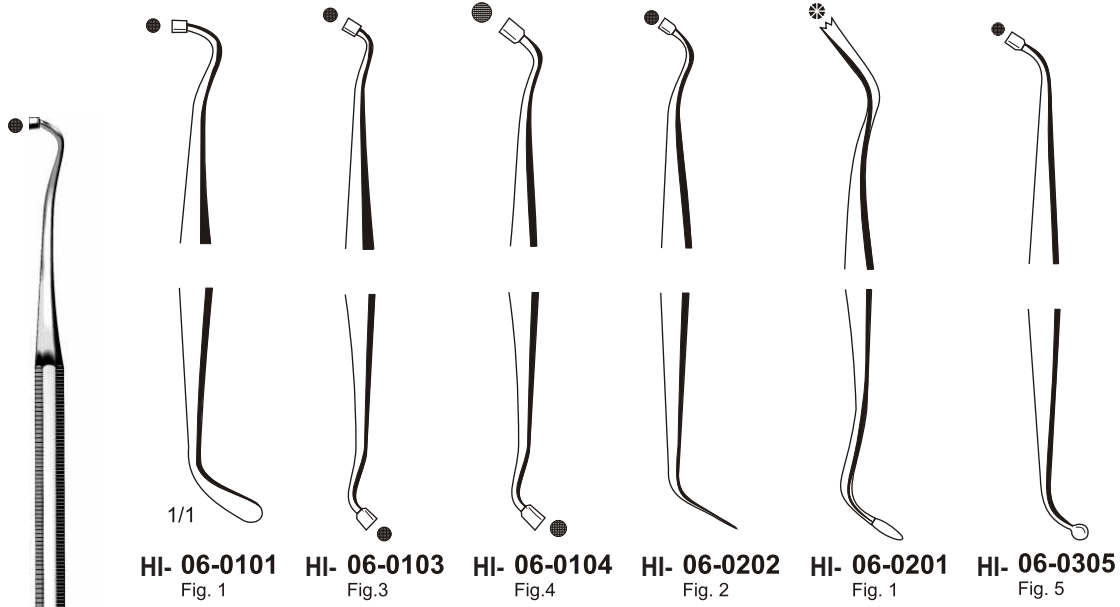

HI-06-0101 - HI-06-0315



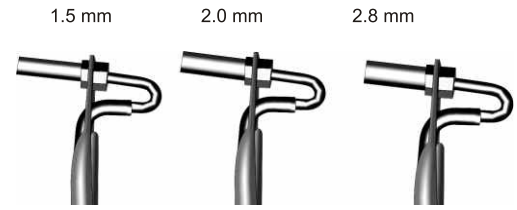
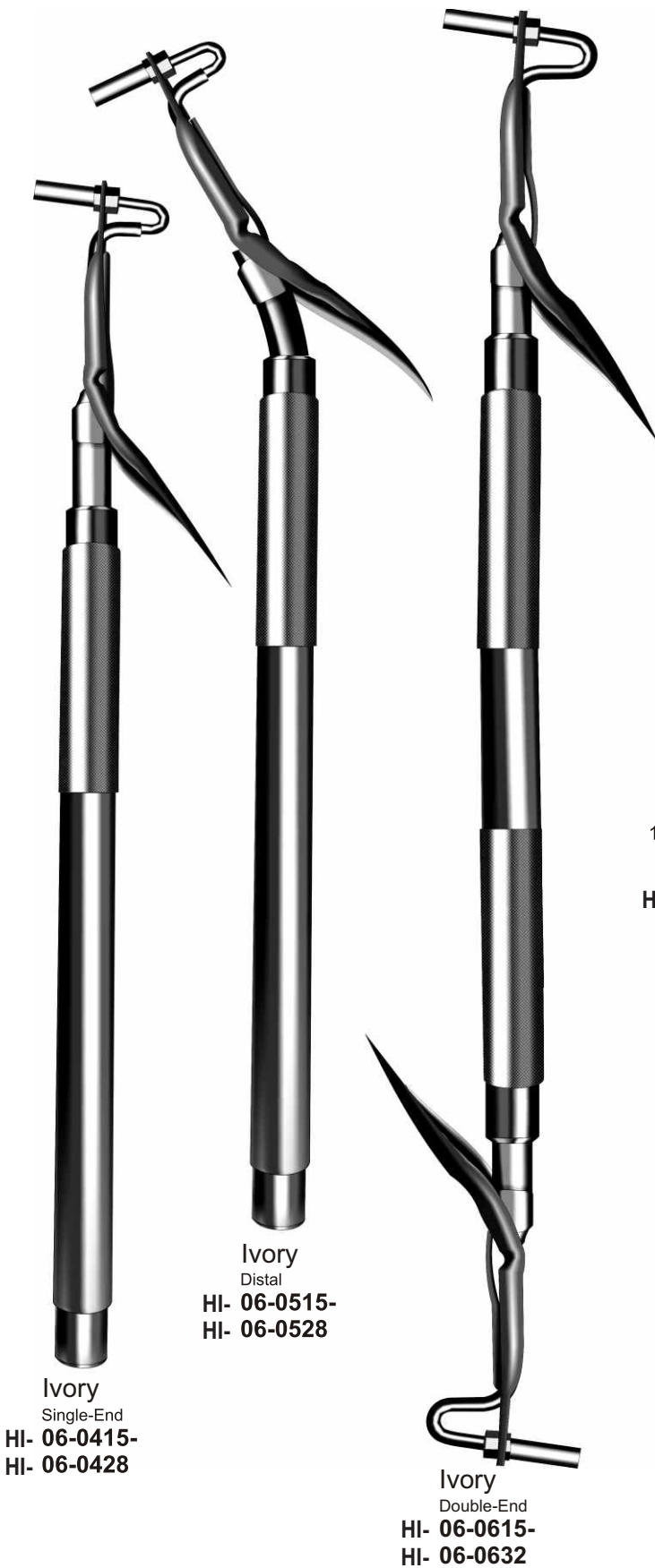

HI- 06-0415    HI- 06-0420    HI- 06-0428  
Mini/ Single-End    Regular/ Single-End    Large/ Single-End



HI- 06-0515    HI- 06-0520    HI- 06-0528  
Mini/ Distal      Regular/ Distal      Large/ Distal

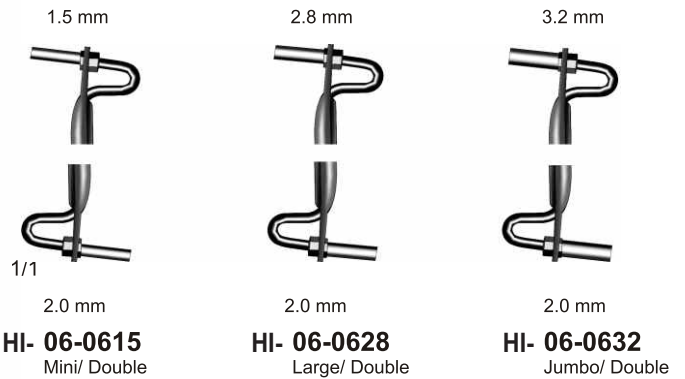

HI- 06-0730  
Ø 30 mm



Amalgam well  
HI- 06-0935  
3,5 cm Ø  
3,5 cm h.



HI- 06-0830  
Ø 30 mm



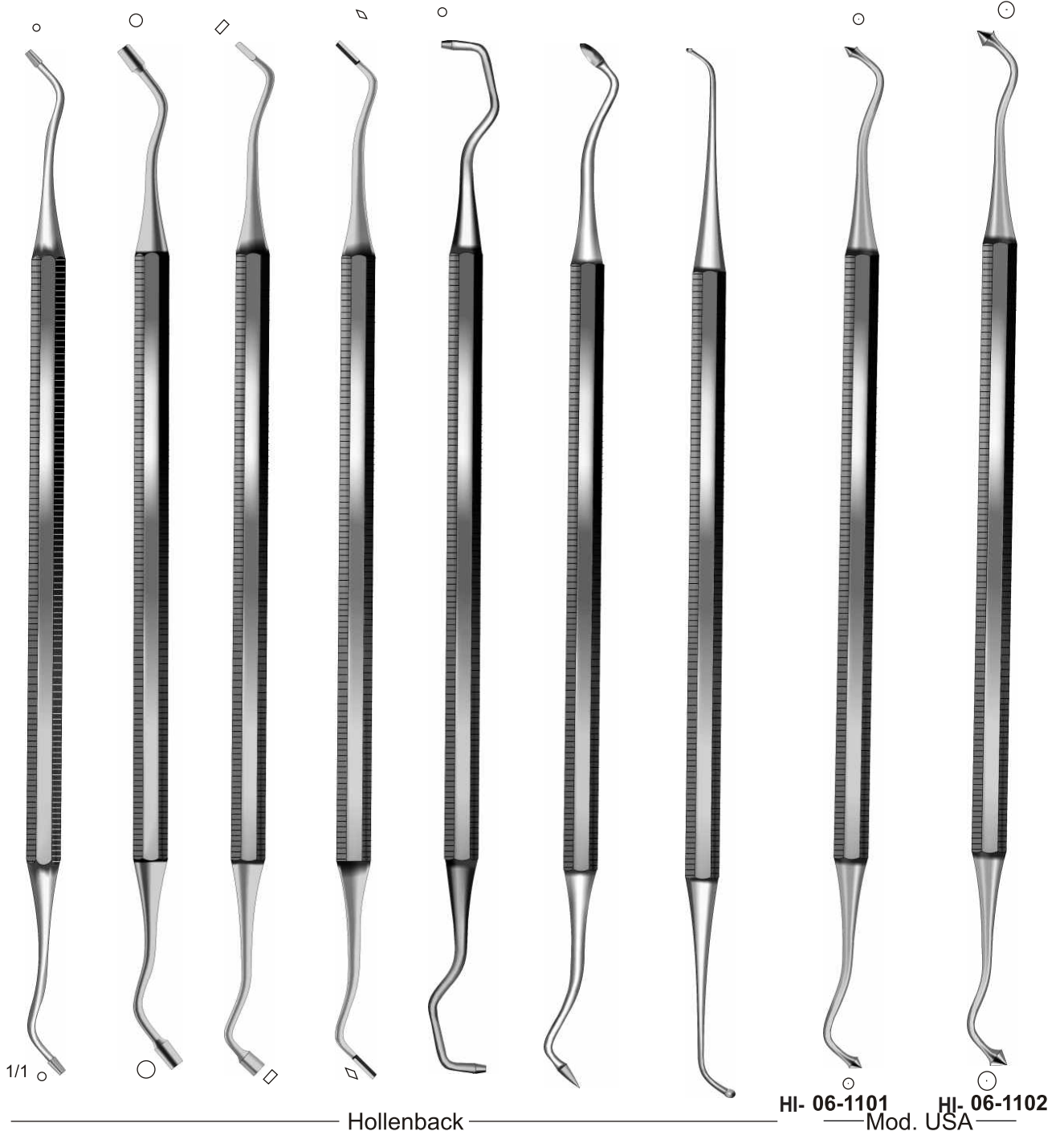

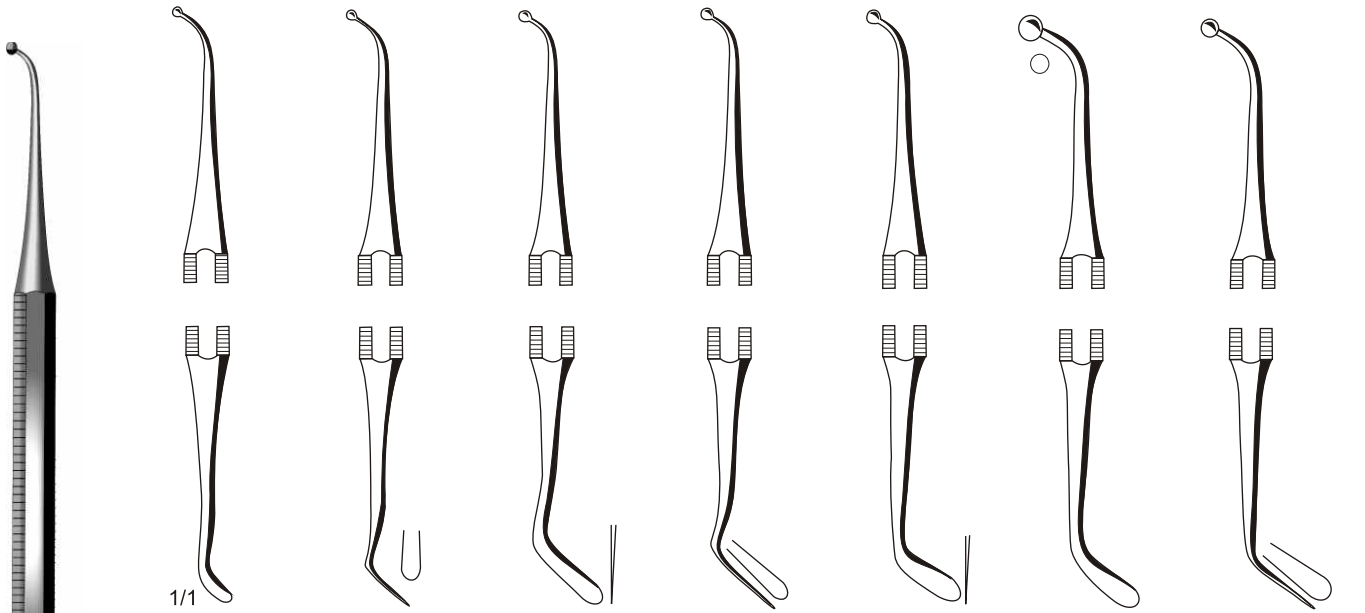

Mod. PHF

HI- 06-1201  
Fig.1

HI- 06-1202  
Fig.2

HI- 06-1303  
Fig.3

HI- 06-1403  
Fig.3 A

HI- 06-1404  
Fig.4

HI- 06-1504  
Fig.4 A

HI- 06-1544  
Fig.4 R

HI- 06-1201 -  
HI- 06-1544  
16cm/6 1/4"

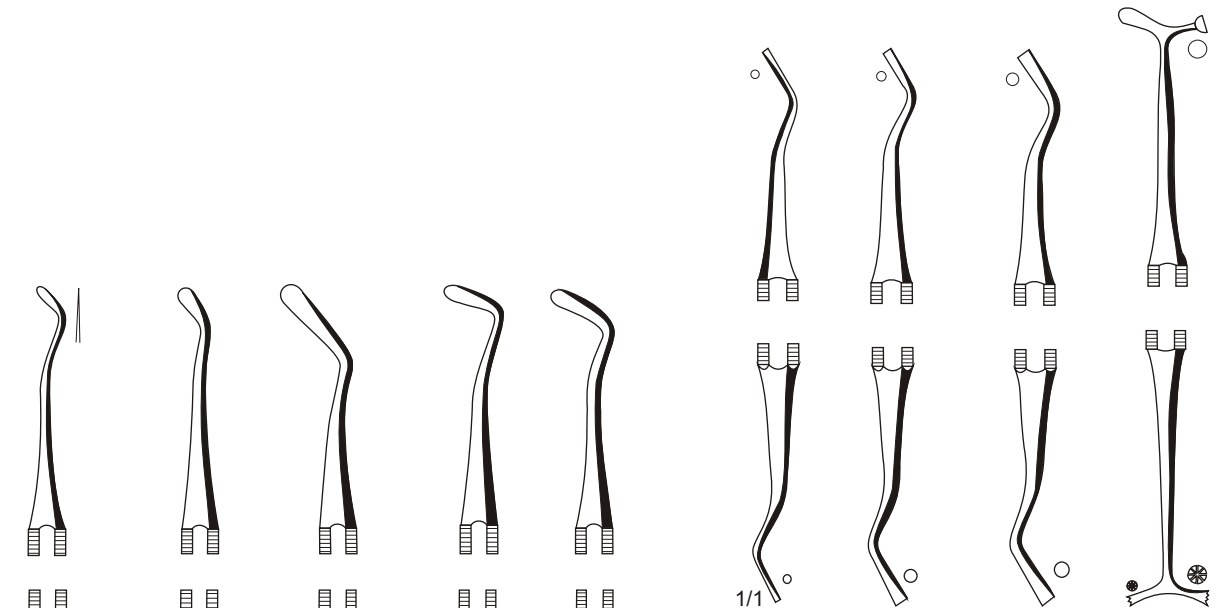

Williams

HI- 06-1700  
Fig.0

HI- 06-1701  
Fig.1

HI- 06-1702  
Fig.2

HI- 06-1703  
Fig.3

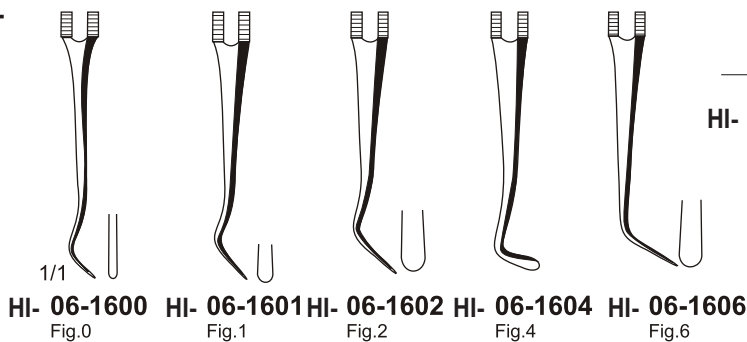

HI- 06-1600  
Fig.0

HI- 06-1601  
Fig.1

HI- 06-1602  
Fig.2

HI- 06-1604  
Fig.4

HI- 06-1606  
Fig.6

Please see page 34 for different handle styles.

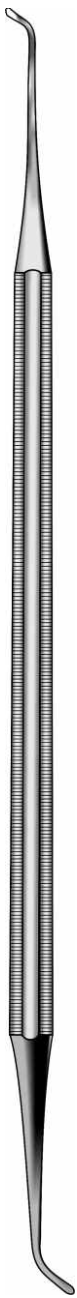

HI- 06-1800 -  
HI- 06-2205

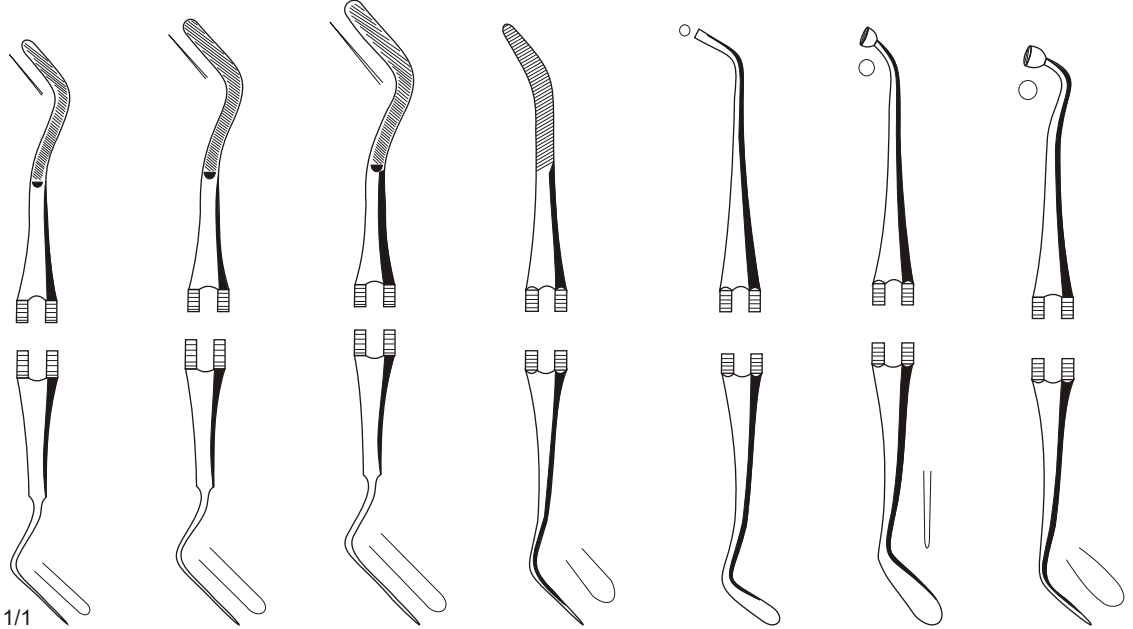

1/1

Heidemann White Woodson  
 HI- 06-1800 Fig.0 HI- 06-1801 Fig.1 HI- 06-1802 Fig.2 HI- 06-1903 Fig.1 HI- 06-1904 Fig.3 HI- 06-1905 Fig.2 HI- 06-1906 Fig.3



1/1

White Ash  
 HI- 06-2103 Fig.3 HI- 06-2104 Fig.4 HI- 06-2105 Fig.5 HI- 06-2201 Fig.1 HI- 06-2202 Fig.2 HI- 06-2203 Fig.3 HI- 06-2204 Fig.4 HI- 06-2205 Fig.5

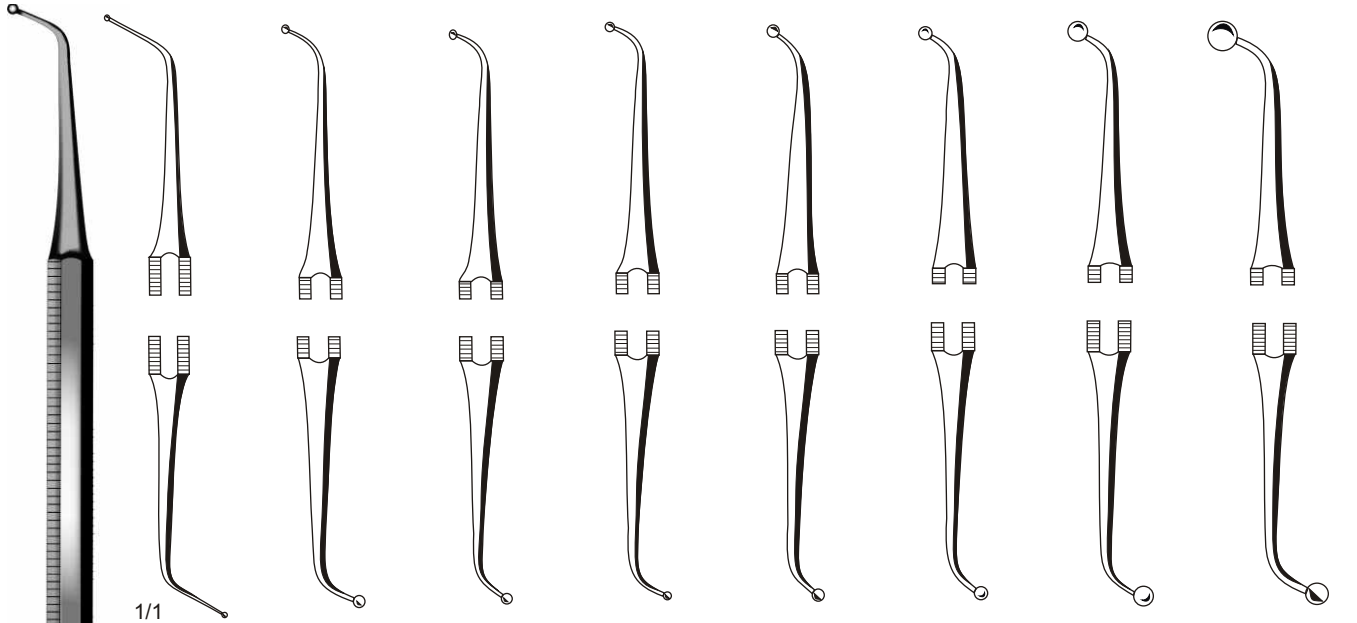

1/1

Mod. PHF

HI- 06-2301 Fig.1   HI- 06-2302 Fig.2   HI- 06-2303 Fig.3   HI- 06-2304 Fig.4   HI- 06-2305 Fig.5   HI- 06-2306 Fig.6   HI- 06-2307 Fig.7 A   HI- 06-2407 Fig.7 B

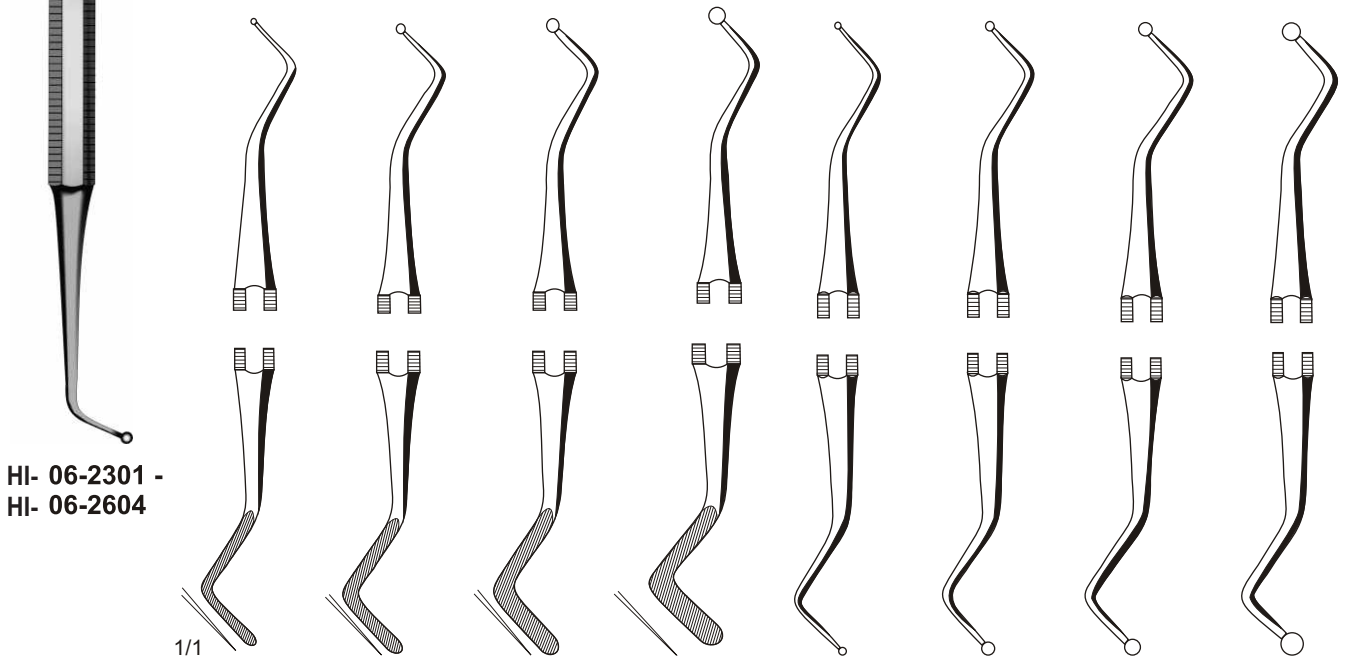

HI- 06-2301 -  
HI- 06-2604

1/1

HI- 06-2501 Fig.1   HI- 06-2502 Fig.2   HI- 06-2503 Fig.3   HI- 06-2504 Fig.4   HI- 06-2601 Fig.1   HI- 06-2602 Fig.2   HI- 06-2603 Fig.3   HI- 06-2604 Fig.4

Please see page 34 for different handle styles.



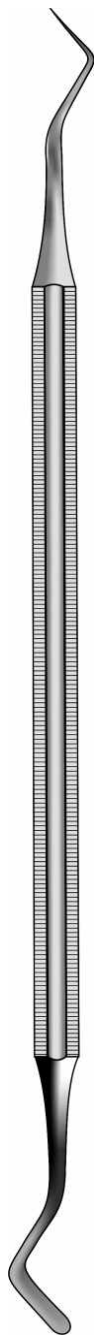

HI-06-2713 - HI-06-3037

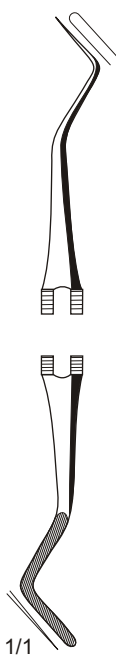

HI- 06-2713  
Fig.13

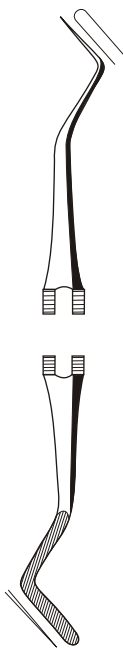

HI- 06-2714  
Fig.14

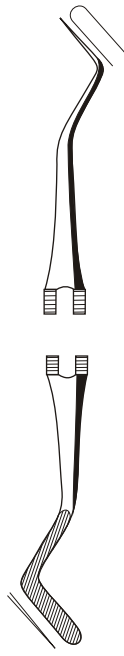

HI- 06-2715  
Fig.15

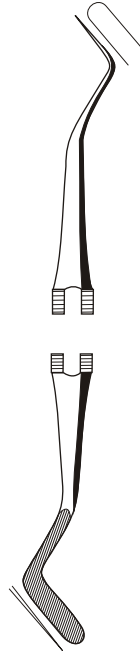

HI- 06-2716  
Fig.16

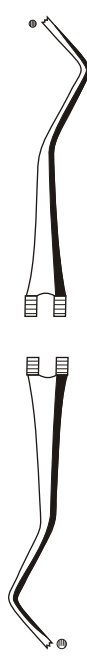

HI- 06-2826  
Fig.26

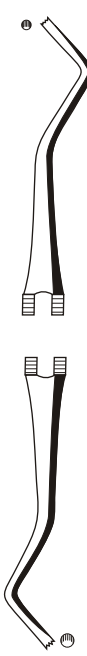

HI- 06-2827  
Fig.27

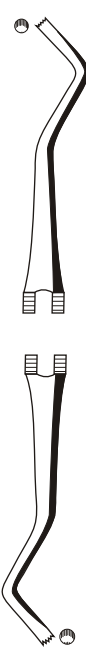

HI- 06-2828  
Fig.28

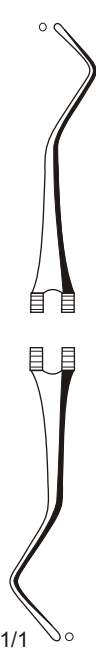

HI- 06-2917  
Fig.17

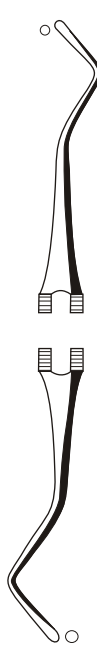

HI- 06-2918  
Fig.18

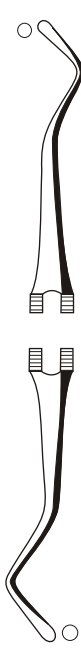

HI- 06-2919  
Fig.19

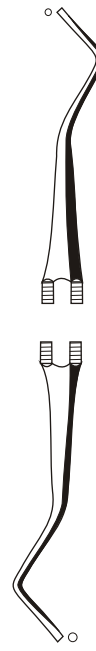

HI- 06-3035  
Fig.35

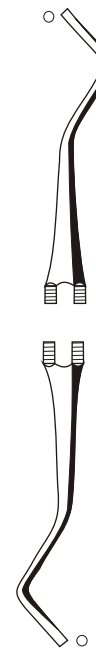

HI- 06-3036  
Fig.36

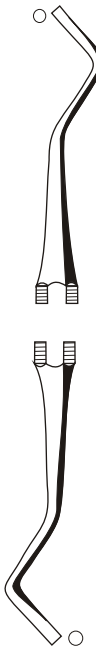

HI- 06-3037  
Fig.37

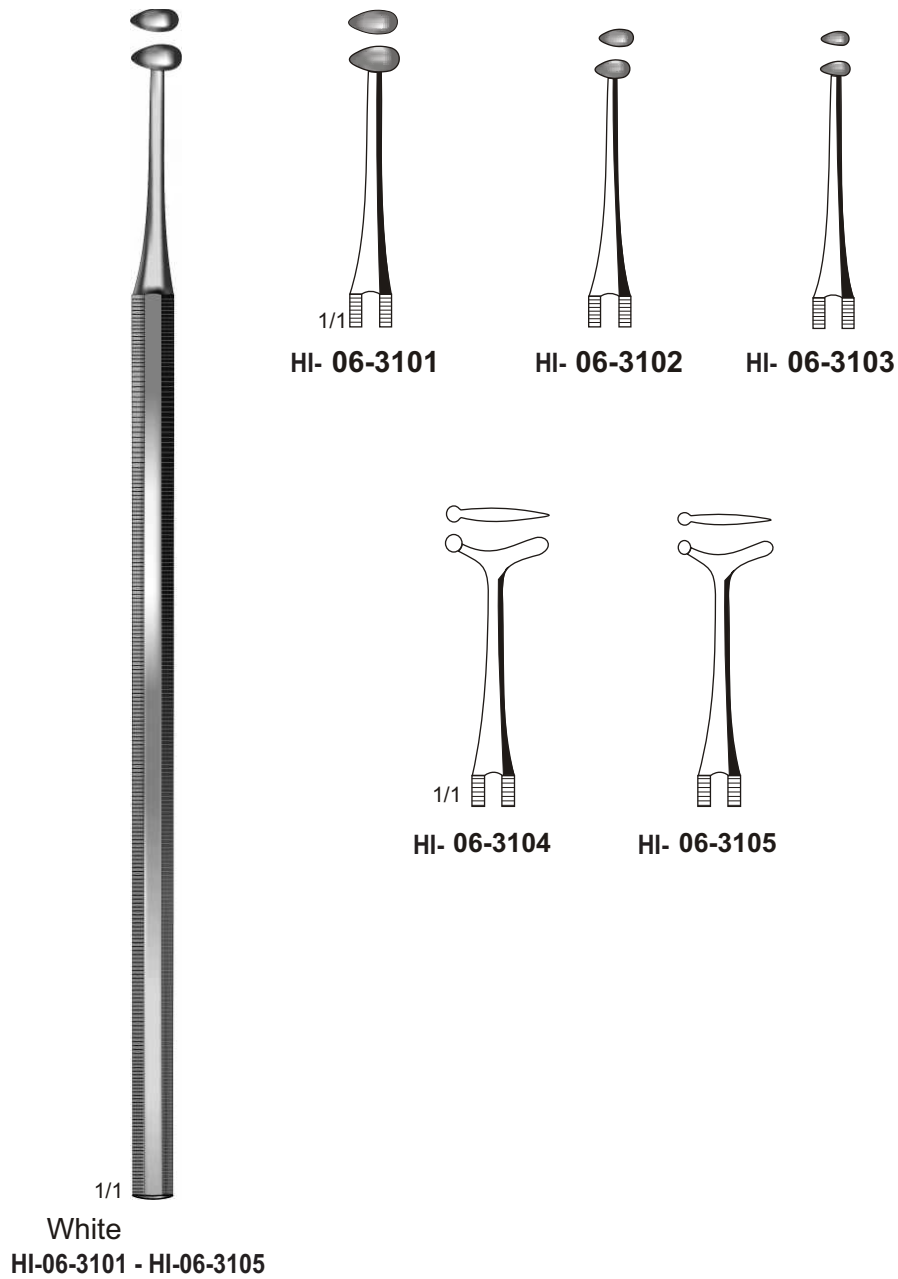

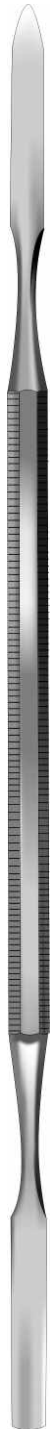

1/1

**HI- 06-3201**  
Fig.1



**HI- 06-3202**  
Fig.2



**HI- 06-3203**  
Fig.3

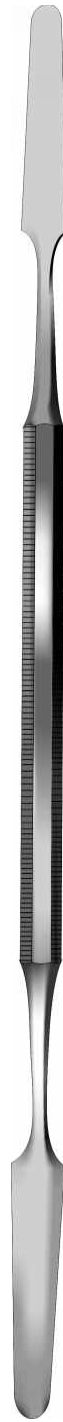
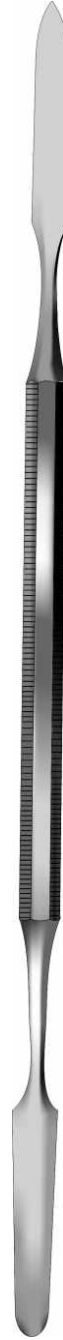
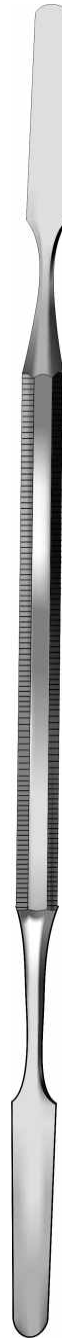

**HI-06-3201 - HI-06-3203**

**HI- 06-3301**

**HI- 06-3302**

**HI- 06-3304**







**HI- 07-0134**  
Fig.33 ½



**HI- 07-0135**  
Fig.34 ½



**HI- 07-0201**  
Fig.1



**HI- 07-0204**  
Fig.4



**HI- 07-0205**  
Fig.5



**HI- 07-0206**  
Fig.6



**HI- 07-0211**  
Fig.11

Darby-Perry



**HI- 07-0301**  
Fig.1



**HI- 07-0302**  
Fig.2



**HI- 07-0303**  
Fig.3



**HI- 07-0322**  
Fig.22



**HI- 07-0333**  
Fig.33



**HI- 07-0344**  
Fig.44

**HI-07-0134 - HI-07-0618**  
15.5 cm/ 6"



**HI- 07-0412**  
Fig.12



**HI- 07-0533**  
Fig.33



**HI- 07-0534**  
Fig.34



**HI- 07-0535**  
Fig.35

Jaquette



**HI- 07-0617**  
Fig.17



**HI- 07-0618**  
Fig.18

McCall

Please see page 34 for different handle styles.

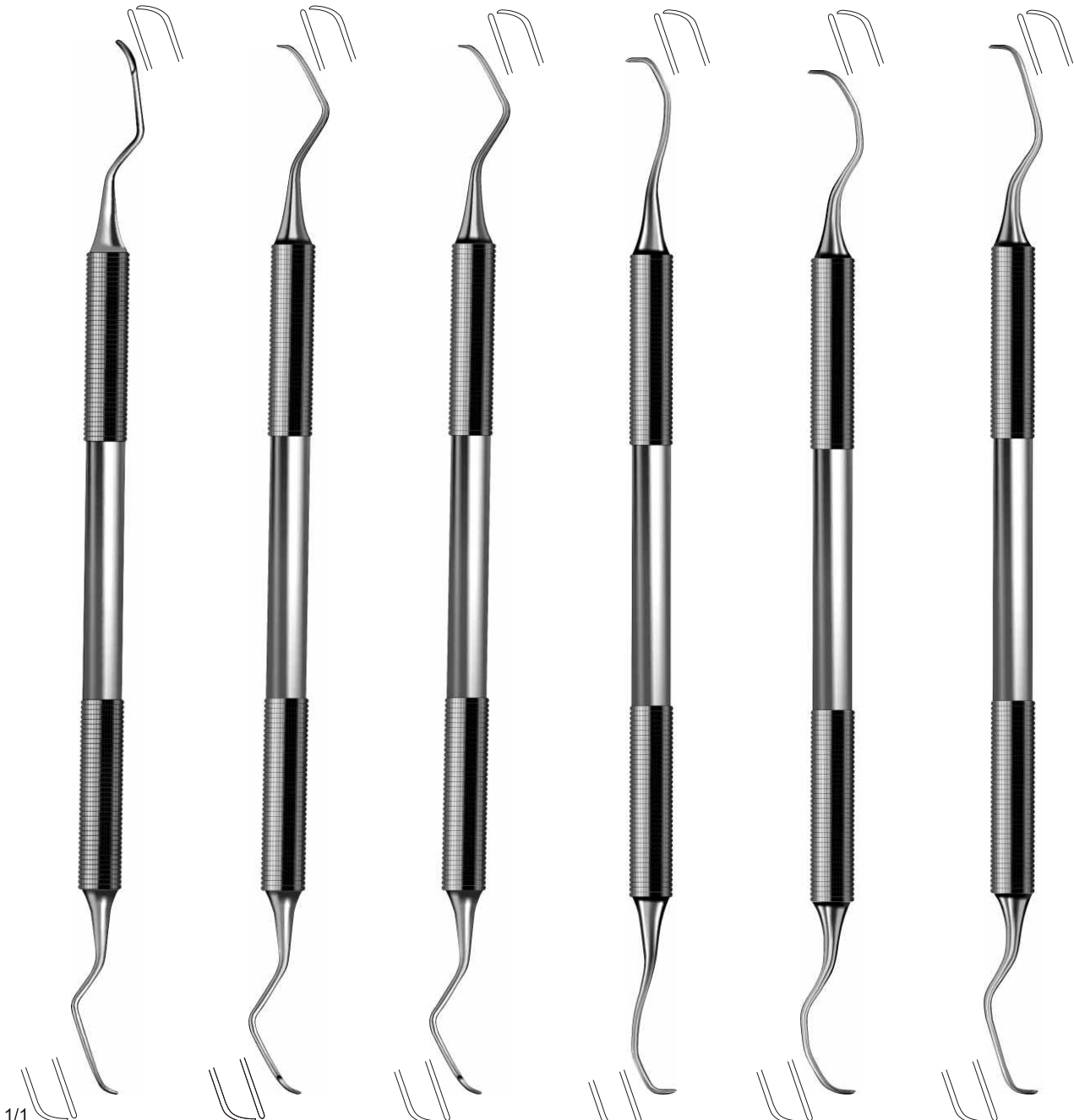

**Columbia**  
**HI- 07-0722**  
 Fig. 2 R/2 L

**Columbia**  
**HI- 07-0744**  
 Fig. 4 R/4 L

**Columbia**  
**HI- 07-0734**  
 Fig. 13/14

**Langer**  
**HI- 07-0812**  
 Fig. ½

**Langer**  
**HI- 07-0834**  
 Fig. ¾

**Langer**  
**HI- 07-0856**  
 Fig. 5/6



Younger-Good  
**HI- 07-0978**  
Fig. 7/8

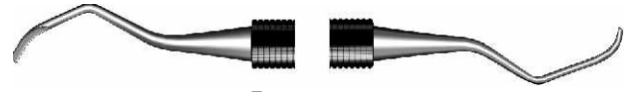

Bates  
**HI- 07-1334**  
Fig. 135/145



Barnhart  
**HI- 07-1012**  
Fig. ½



Rule  
**HI- 07-1434**  
Fig. ¾

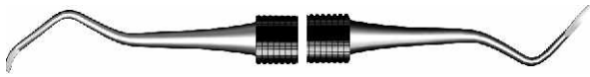

Barnhart  
**HI- 07-1056**  
Fig. 5/6



**HI- 07-1441**  
Fig. 411/412

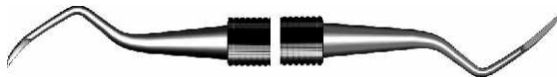

Indiana University (Anterior)  
**HI- 07-1134**  
Fig. 13/14+

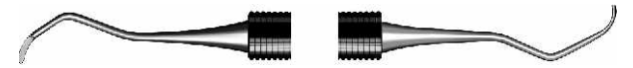

**HI- 07-1541**  
Fig. 413/414



Indiana University (Posterior)  
**HI- 07-1178**  
Fig. 17/18+



Mallery  
**HI- 07-1612**  
Fig. ½



Bunting  
**HI- 07-1212**  
Fig. ½+



Goldman  
**HI- 07-1632**  
Fig. 31/32

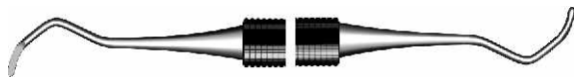

Bunting  
**HI- 07-1256**  
Fig. 5/6

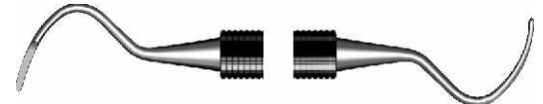

**HI- 07-1711**  
Fig. 1



Anterior  
**HI- 07-1812**  
Fig. ½

Please see page 34 for different handle styles.

# CH 08

**Periodontia Instruments**  
**Instrumente Zur paradontologie**  
**Instrumentos para periodoncia**  
**Instruments pour la parodontologie**  
**Strumenti per parodontologia**





Periodontia Probes

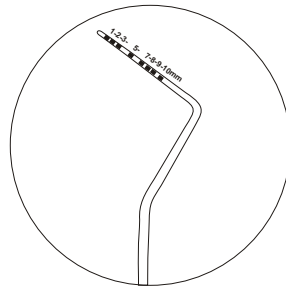
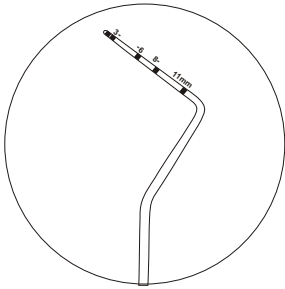

HI- 08-0100  
Fig. 8

HI- 08-0101  
Fig. W

HI- 08-0108  
Fig. 11

HI- 08-0110  
Fig. 0

HI- 08-0111  
Fig. 10

HI- 08-0112  
Fig. WHO

HI- 08-0201 HI- 08-0301 HI- 08-0302

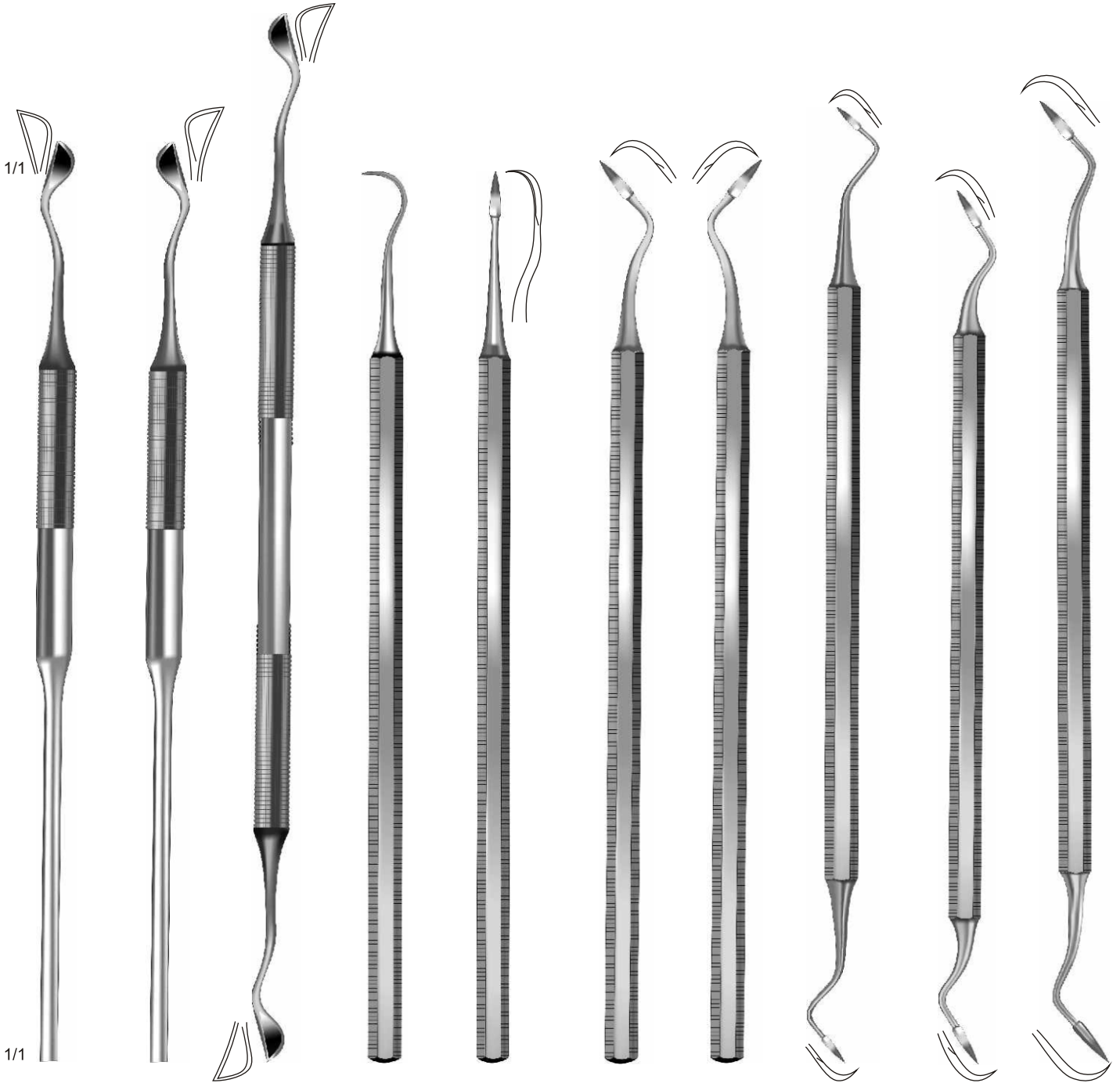

Kirkland HI- 08-0415  
 Kirkland HI- 08-0416  
 Kirkland HI- 08-0501  
 HI- 08-0604 Fig. ST 15  
 Ward-Kirkland HI- 08-0701  
 Carne-Kaplan HI-08-0802 - HI-08-0803  
 HI- 08-0901 Fig. ST2/3  
 HI- 08-0902 Fig. SCI 2/3  
 HI- 08-0903 Fig. SCK 6

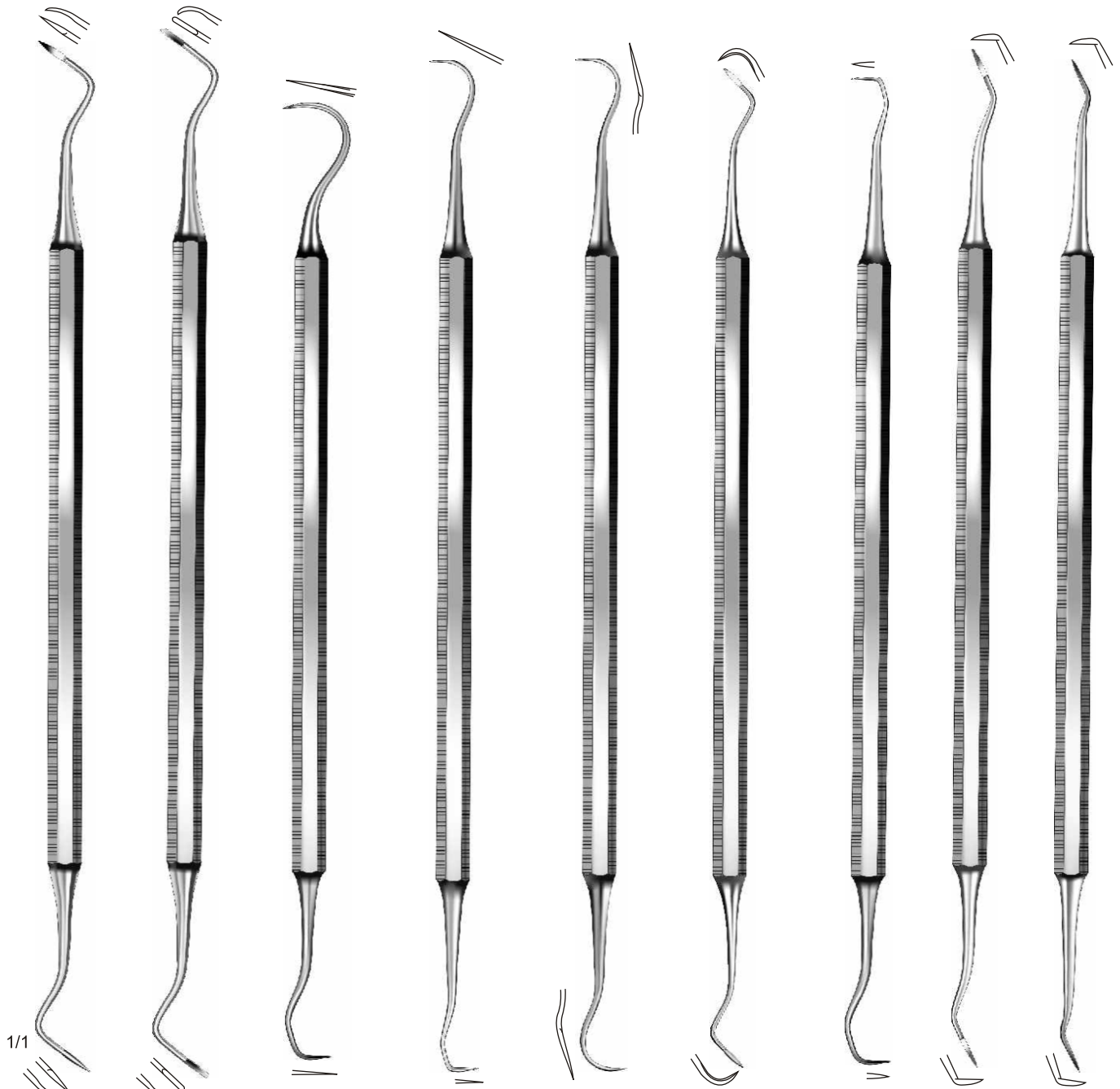

McCall	McCall	Townner-Jaquette		Hygienist		Jaquette		
<b>HI- 08-1034</b>	<b>HI- 08-1134</b>	<b>HI- 08-1230</b>	<b>HI- 08-1233</b>	<b>HI- 08-1267</b>	<b>HI- 08-1304</b>	<b>HI- 08-1401</b>	<b>HI- 08-1402</b>	<b>HI- 08-1403</b>
Fig. 13 S/14 S	Fig. 13/14	Fig. 15/30	Fig. 5/33	Fig. 6/7	Fig. 204 S	Fig. 30/33	Fig. 31/32	Fig. 34/35

Please see page 34 for different handle styles.



Goldman-Fox  
 HI- 08-1507 HI- 08-1508 HI- 08-1509 HI- 08-1510 HI- 08-1511 HI- 08-1521

Nabers Cross Prichard  
 HI- 08-1600 HI- 08-1601 HI- 08-1700

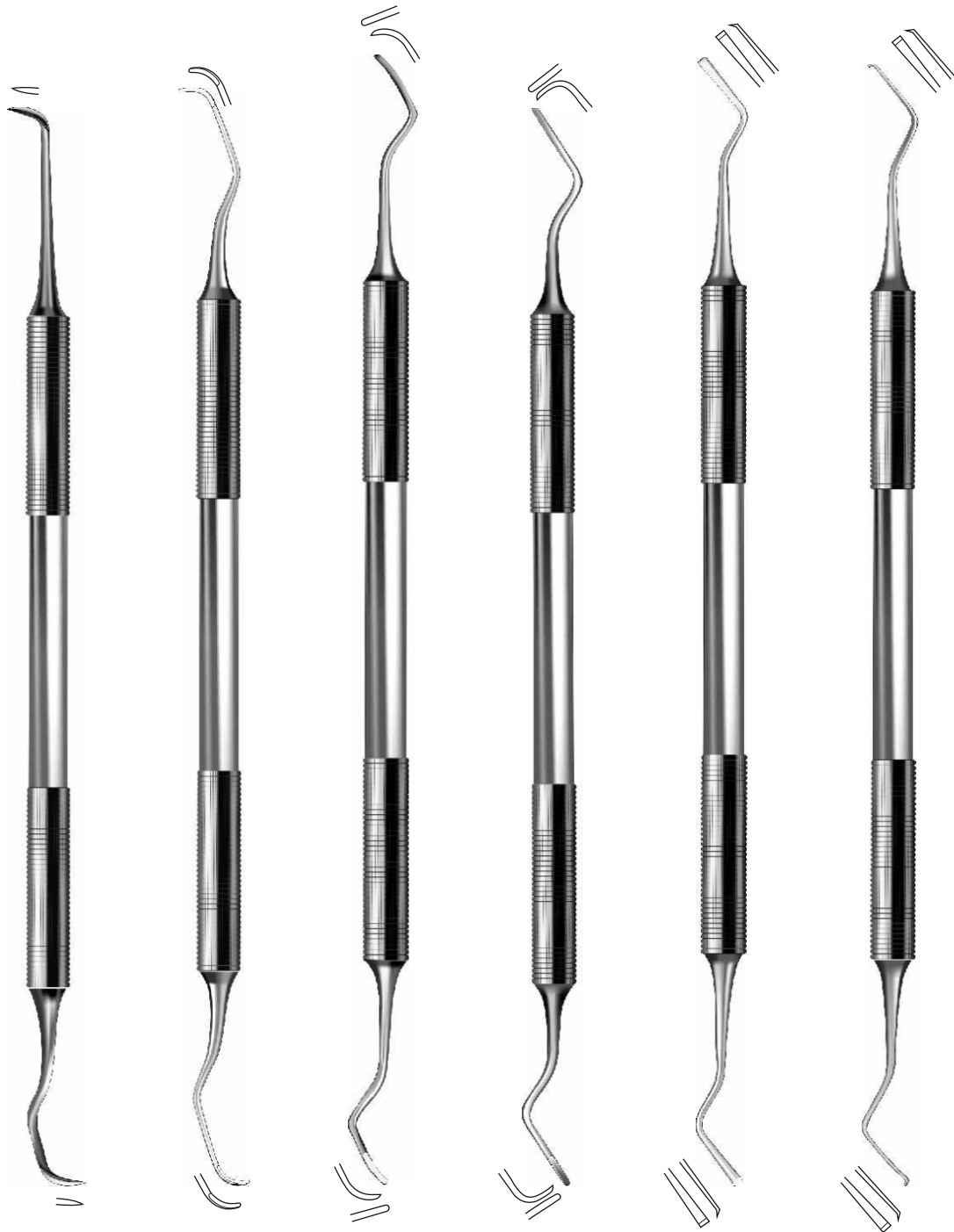

Goldman Fox

<b>HI- 08-2101</b>	<b>HI- 08-2102</b>	<b>HI- 08-2103</b>	<b>HI- 08-2104</b>	<b>HI- 08-2105</b>	<b>HI- 08-2106</b>
16cm/ 6 ¼"	16cm/ 6 ¼"	16cm/ 6 ¼"	16cm/ 6 ¼"	16cm/ 6 ¼"	16cm/ 6 ¼"

*Please see page 34 for different handle styles.*



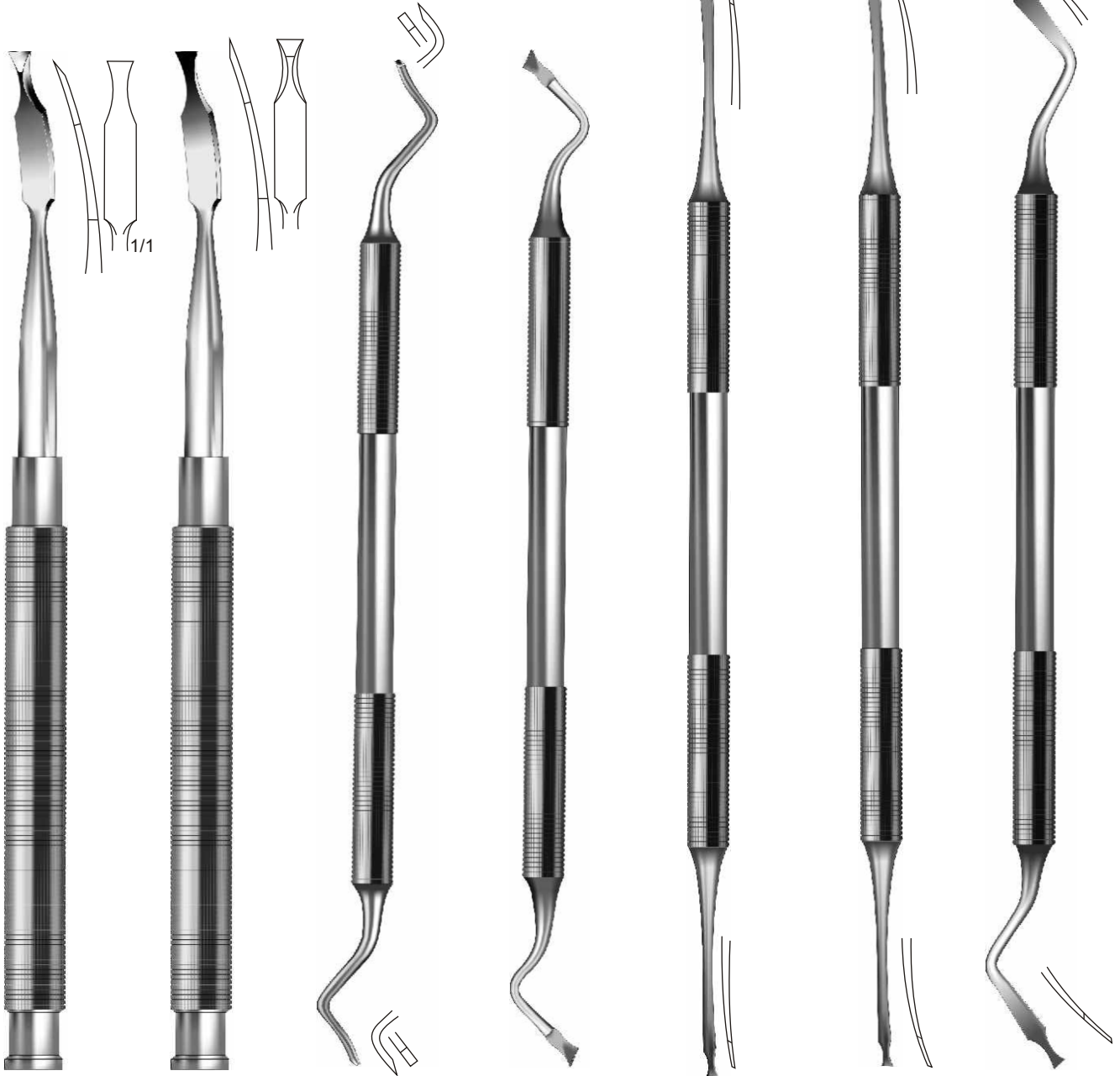

Ochsenbein  
**HI- 08-2201**  
 Fig. 1

Ochsenbein  
**HI- 08-2202**  
 Fig. 2

Ochsenbein  
**HI- 08-2303**  
 Fig. 3

Ochsenbein  
**HI- 08-2304**  
 Fig. 4

Fedi  
**HI- 08-2501**  
 Fig. 1

Fedi  
**HI- 08-2502**  
 Fig. 2

Fedi  
**HI- 08-2503**  
 Fig. 3

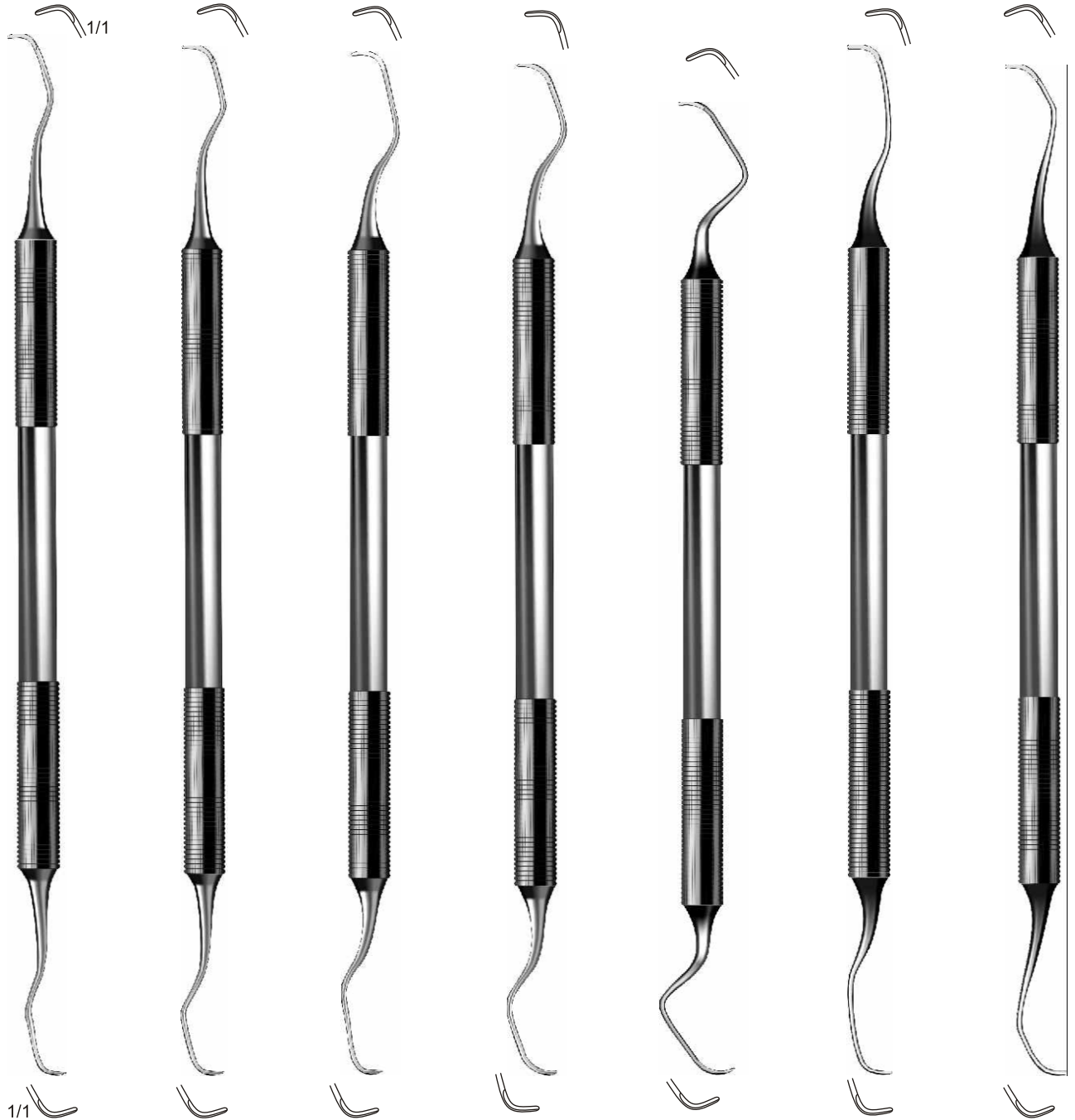

<b>HI- 08-2612</b>	<b>HI- 08-2634</b>	<b>HI- 08-2656</b>	<b>HI- 08-2678</b>	<b>HI- 08-2690</b>	<b>HI- 08-2692</b>	<b>HI- 08-2694</b>
Fig. 1/2	Fig. 3/4	Fig. 5/6	Fig. 7/8	Fig. 9/10	Fig. 11/12	Fig. 13/14

Gracey

Please see page 34 for different handle styles.

## CH 09

**Excavators, Probes &  
Explorers, Nerve instruments**  
Exkavatoren, Zahnsonden,  
Nervinstrumente  
Excavadores, sondas y  
exploradores, Instrumentos  
para nervios  
Excavateurs, Sondes, et  
explorateurs  
Escavatori, Sonde, Strumenti  
per nervi



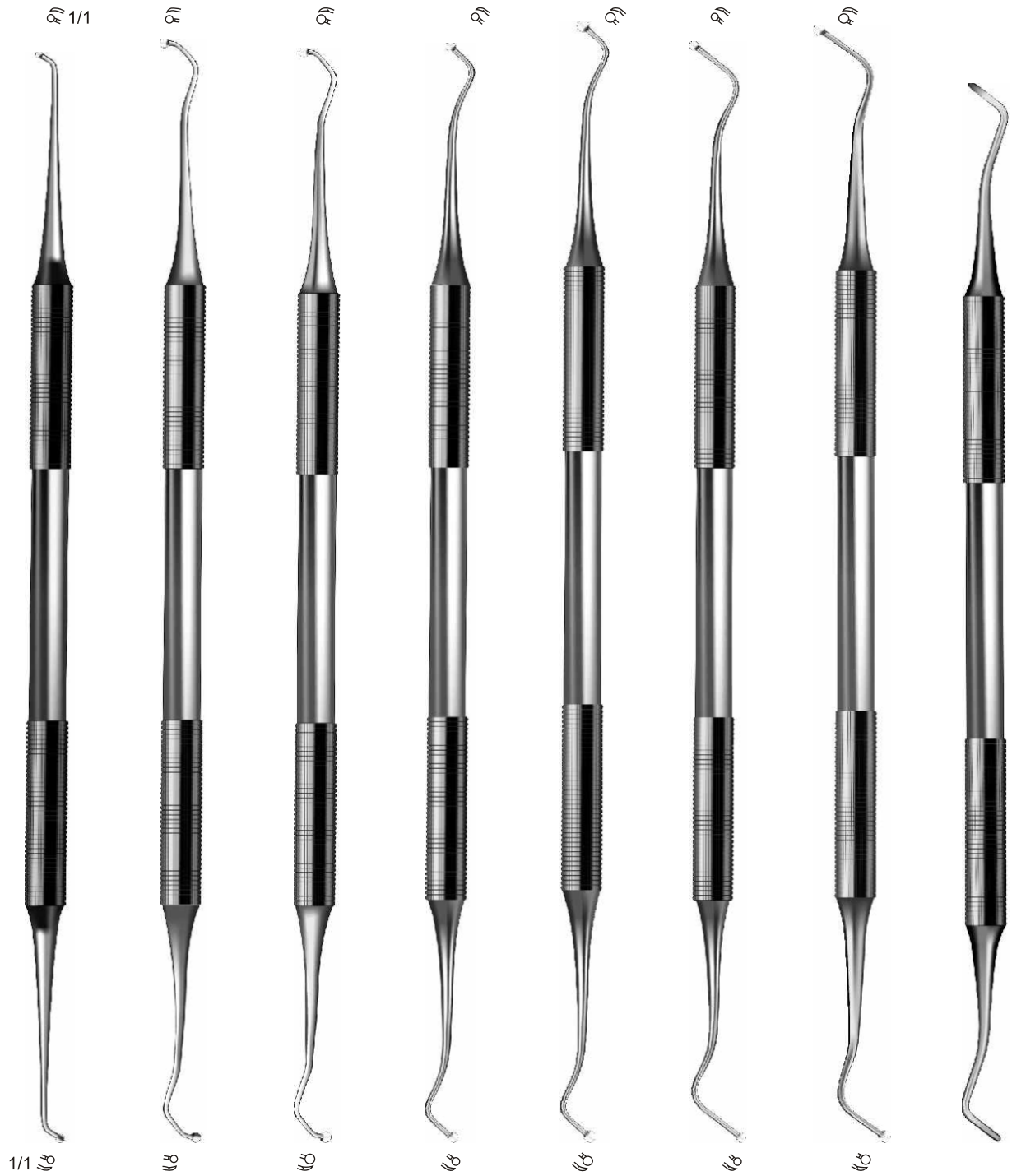

HI- 09-0105 HI- 09-0113 HI- 09-0114 HI- 09-0117 HI- 09-0118 HI- 09-0131 HI- 09-0133 HI- 09-0135

*Please see page 34 for different handle styles.*

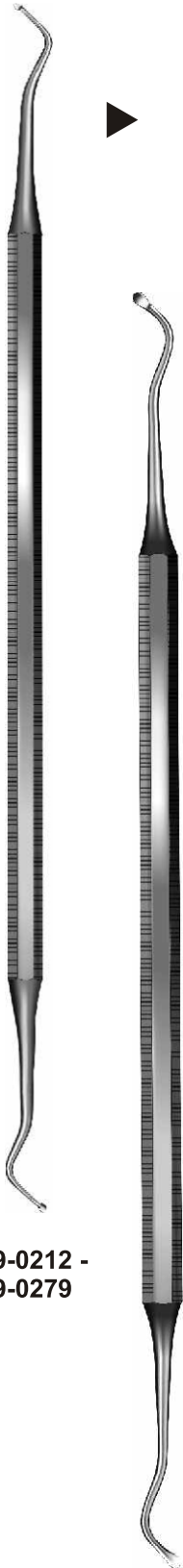

HI- 09-0212 -  
HI- 09-0279

HI- 09-0305 -  
HI- 09-0320

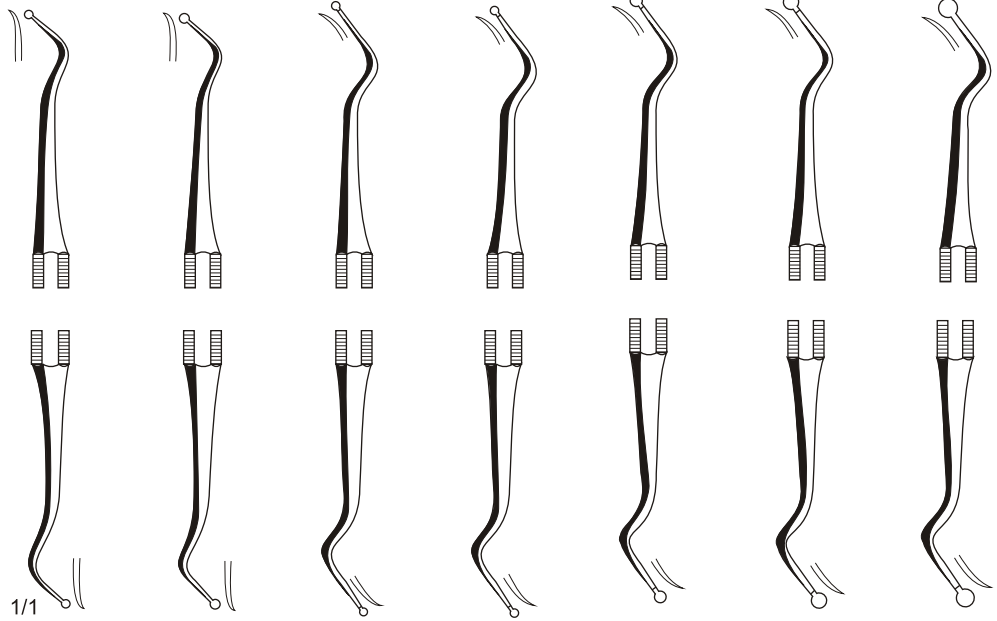

HI- 09-0212 Fig. 12/13    HI- 09-0214 Fig. 14/15    HI- 09-0217 Fig. 171/172    HI- 09-0273 Fig. 173/174    HI- 09-0275 Fig. 175/176    HI- 09-0277 Fig. 177/178    HI- 09-0279 Fig. 179/180

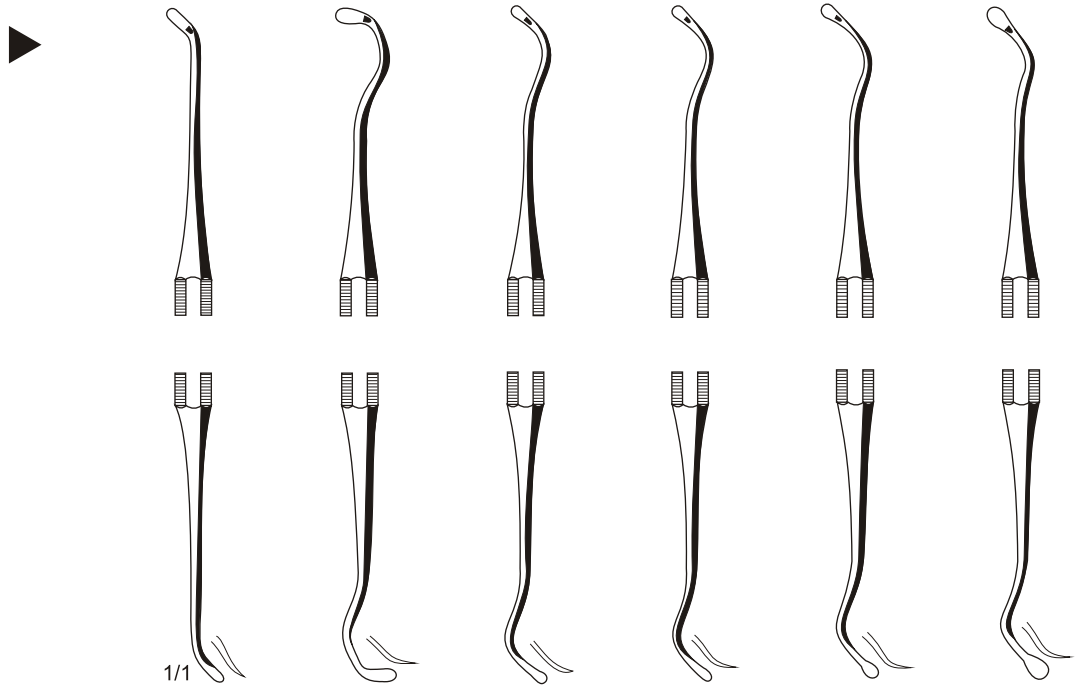

White  
HI- 09-0305 Fig. 5    HI- 09-0314 Fig. 14    HI- 09-0317 Fig. 17    HI- 09-0318 Fig. 18    HI- 09-0319 Fig. 19    HI- 09-0320 Fig. 20



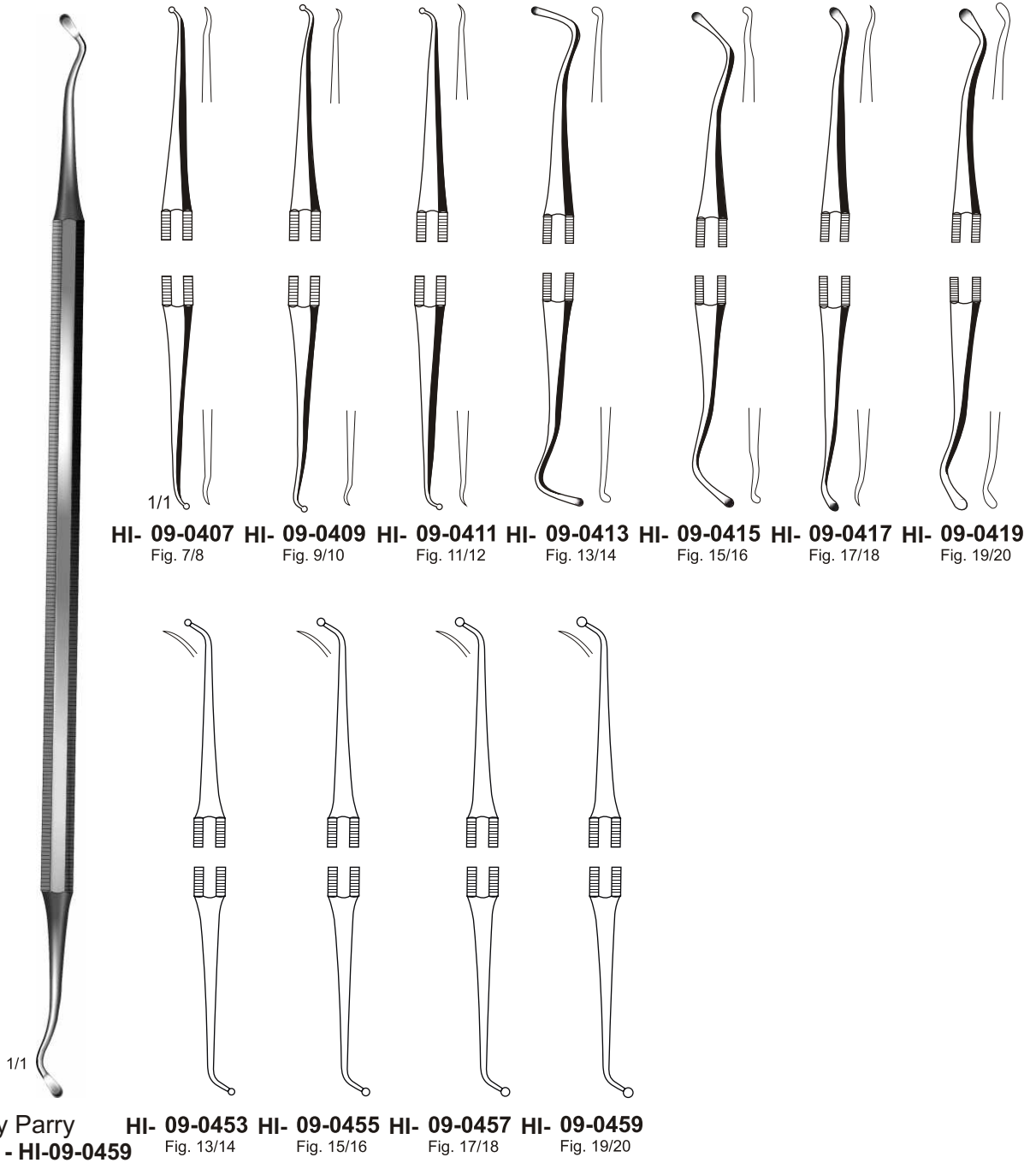



**HI- 09-0503**  
Fig. 3/4

**HI- 09-0505**  
Fig. 5/6

**HI- 09-0507**  
Fig. 7/8

**HI- 09-0509**  
Fig. 9/10

**HI- 09-0511**  
Fig. 11/12

**HI- 09-0513**  
Fig. 13/14

**HI- 09-0515**  
Fig. 15/16

**HI- 09-0503-  
HI- 09-0525**



**HI- 09-0517**  
Fig 17/18

**HI- 09-0519**  
Fig 19/20

**HI- 09-0521**  
Fig 21/22

**HI- 09-0523**  
Fig 23/24

**HI- 09-0525**  
Fig 25/26

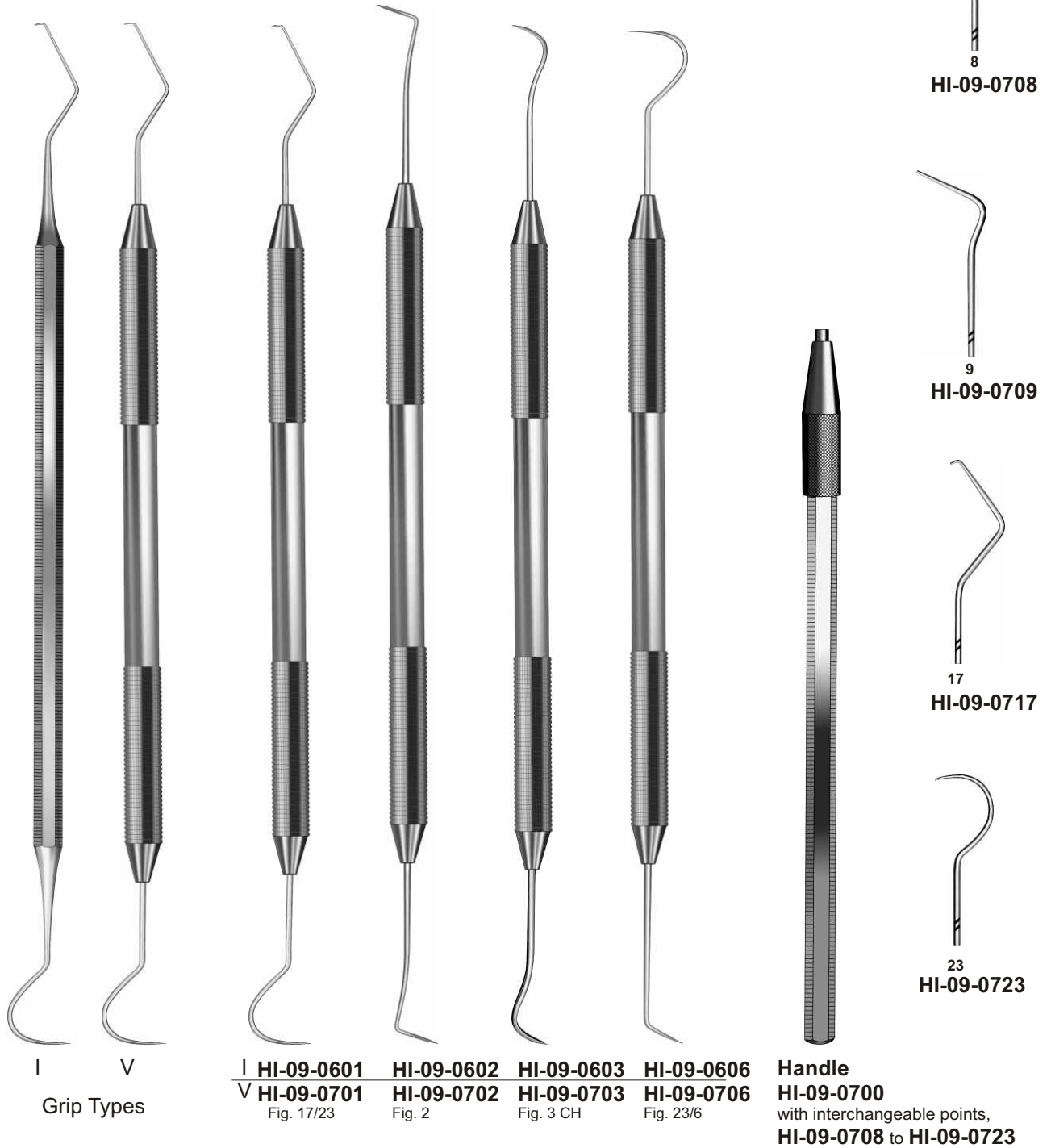

Please see page 34 for different handle styles.



I HI- 09-0803	HI- 09-0806	HI- 09-0808	HI- 09-0809	HI- 09-0810
V HI- 09-0903	HI- 09-0906	HI- 09-0908	HI- 09-0909	HI- 09-0910
Fig. 3	Fig. 6	Fig. 8	Fig. 8 a	Fig. 9



I V  
Grip Types



I HI- 09-0817	HI- 09-0823	HI- 09-0833	HI- 09-0835
V HI- 09-0917	HI- 09-0923	HI- 09-0933	HI- 09-0935
Fig. 17	Fig. 23	Fig. 33	Fig. 35



I HI- 09-0842	HI- 09-0843	HI- 09-0844
V HI- 09-0942	HI- 09-0943	HI- 09-0944
Fig. 42	Fig. 43	Fig. 44



I HI- 09-0854	HI- 09-0856	HI- 09-0861
V HI- 09-0954	HI- 09-0956	HI- 09-0961
Fig. 54	Fig. 56	Fig. 61

**Nerve-canal and root-canal condensers**

Nervkanal-und wurzelkanal-stopfer

Tapón para el canal del nervio y el canal de la raíz

Obtuteur de canal nerveux et de canal radiculaire

Condensatori per nervi e canali radicolari

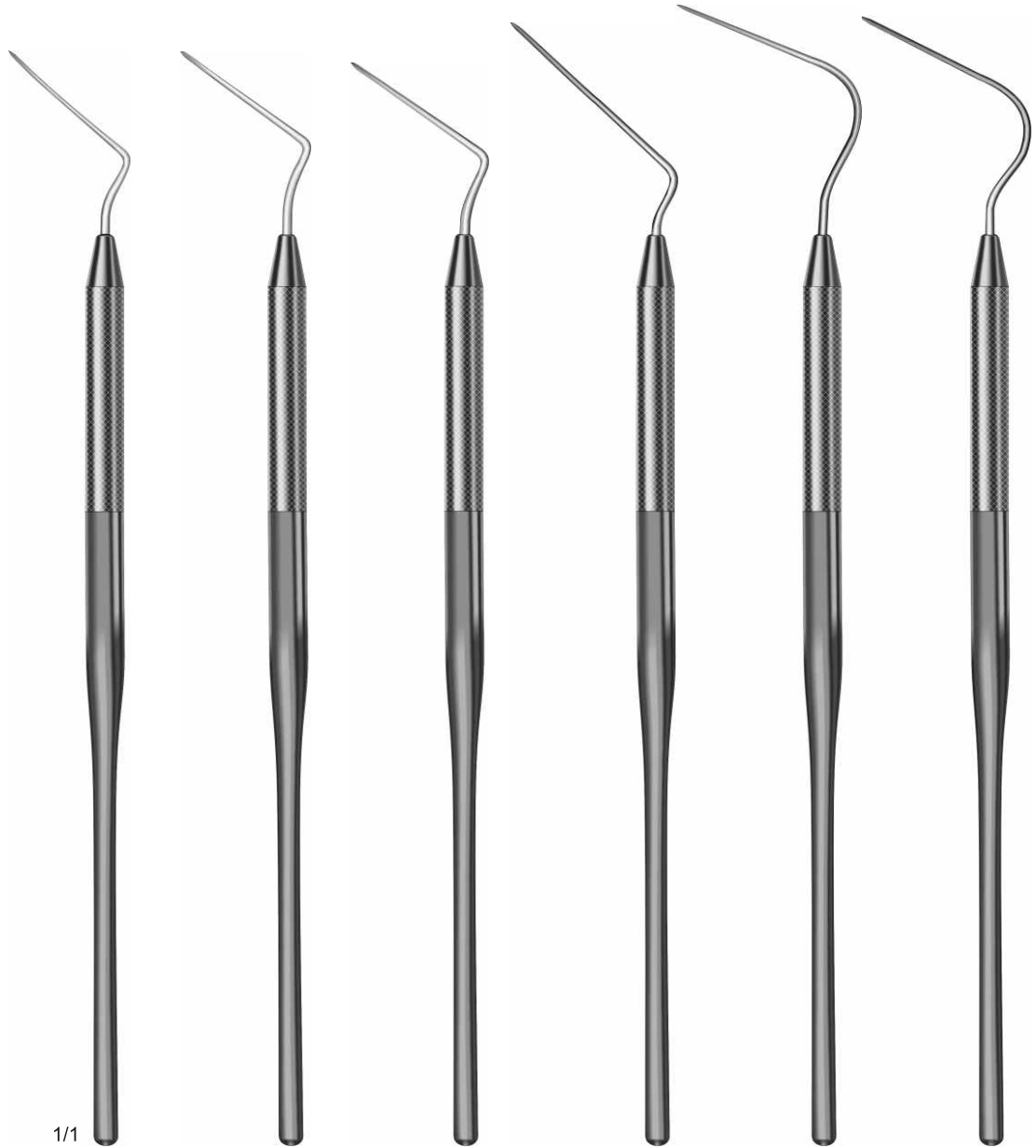

1/1

**HI- 09-1025**  
0,25 mm

**HI- 09-1040**  
0,40 mm

**HI- 09-1060**  
0,60 mm

**HI- 09-1073**  
Fig.3

**HI- 09-1080**  
Fig.0

**HI- 09-1090**  
Fig.00



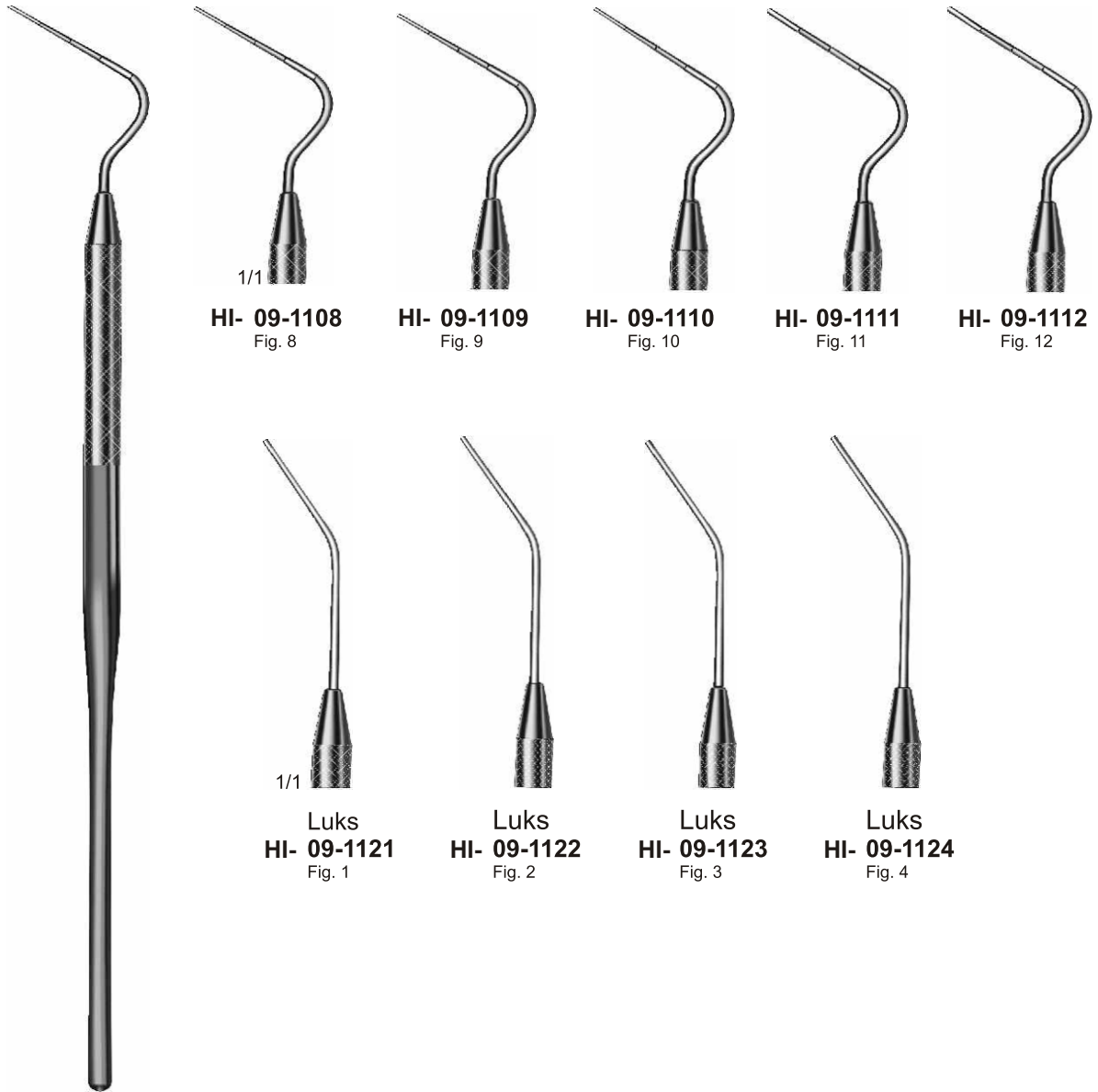

Lusks  
HI-09-1108 - HI-09-1124

**Files / Black Cutting Instruments**

Feilen/ Schneidende instrumente nach Black

Limas para raices/ instrumentos cortantes de Black

Limes/ instruments tranchantes de Black

Lime/ Strumenti da taglio di Black

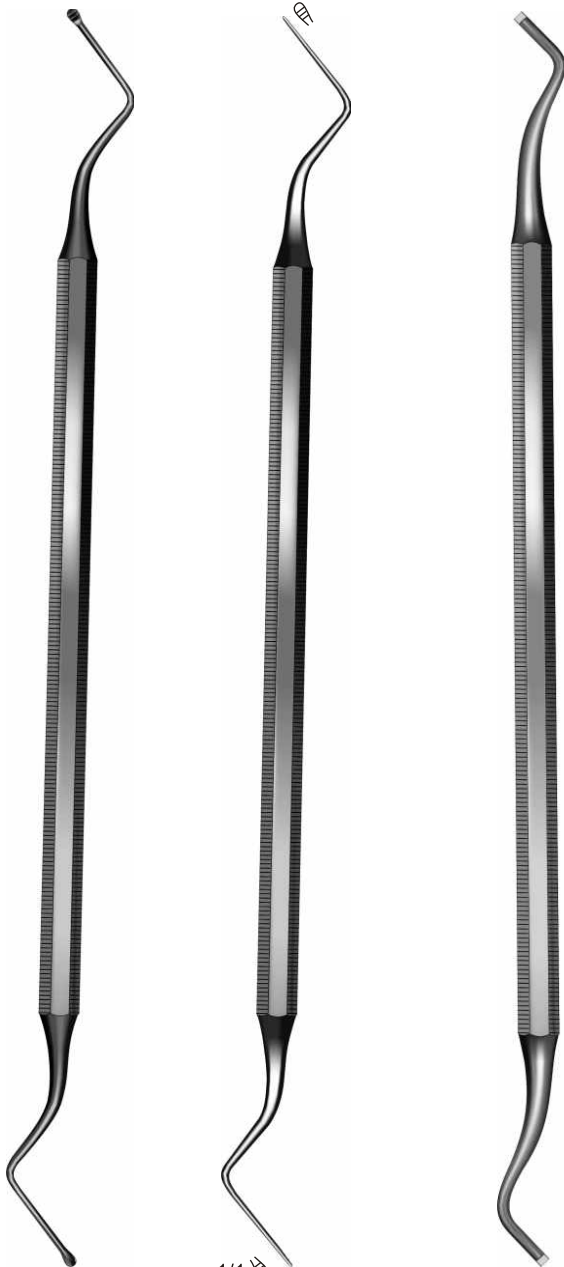

Hirschfeld  
**HI- 09-1237**  
Fig. 3/7

Hirschfeld  
**HI- 09-1211**  
Fig. 5/11

Black  
**HI-09-1351 - HI-09-1379**

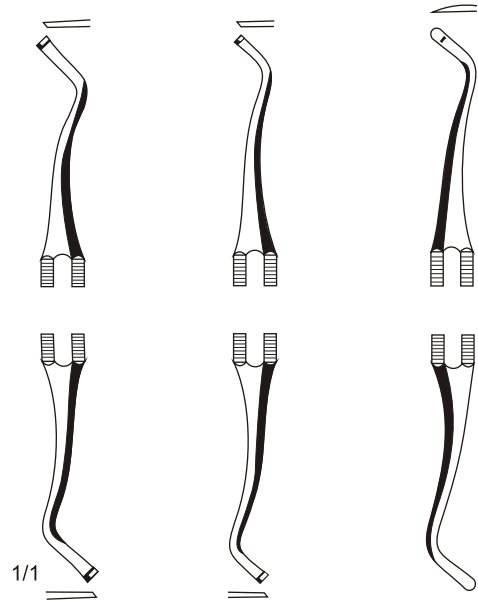

<b>HI- 09-1351</b>	<b>HI- 09-1353</b>	<b>HI- 09-1363</b>
Fig. 51 / Fig. 52	Fig. 53 / Fig. 54	Fig. 63 / Fig. 64
a) 15    15	a) 10    10	a) 15    15
b) 8     8	b) 6     6	b) 8     8
c) 12 L   12 R	c) 12 L   12 R	c) 12 L   12 R

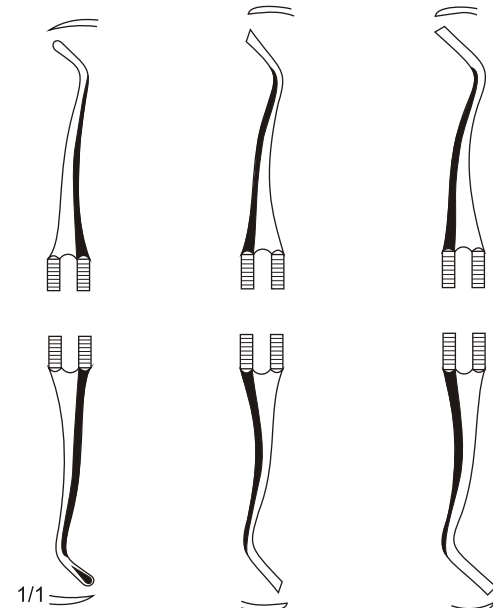

<b>HI- 09-1365</b>	<b>HI- 09-1377</b>	<b>HI- 09-1379</b>
Fig. 65 / Fig. 66	Fig. 77 / Fig. 78	Fig. 79 / Fig. 80
a) 10    10	a) 15    15	a) 15    15
b) 8     6	b) 8     8	b) 8     8
c) 12 L   12 R	c) 12 L   12 R	c) 12 L   12 R

a) Width of blade in 1/10 mm  
b) Length of blade from the centre of angle in mm  
c) Angle of blade to its handle in centigrade

## CH 10

**Wax and Crown Instruments,  
Matrix Instruments**  
Wachs- kroneninstrumente,  
Matrizen-instrumente  
Instrumentos para cera, coronas,  
instrumentos para matrices  
Instruments pour couronnes  
et matrices  
Strumenti per cera e per corone,  
Strumenti per matrici



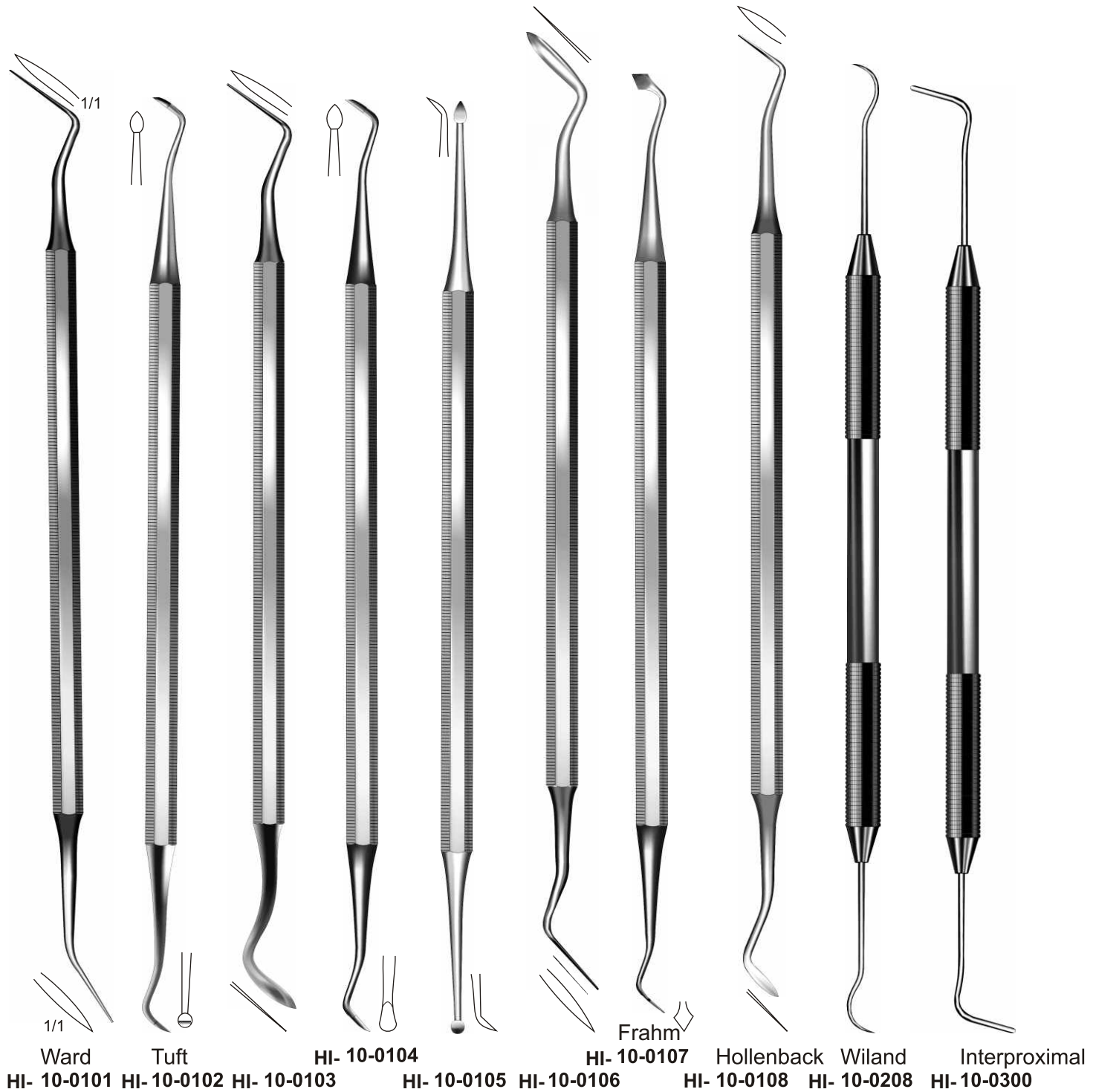

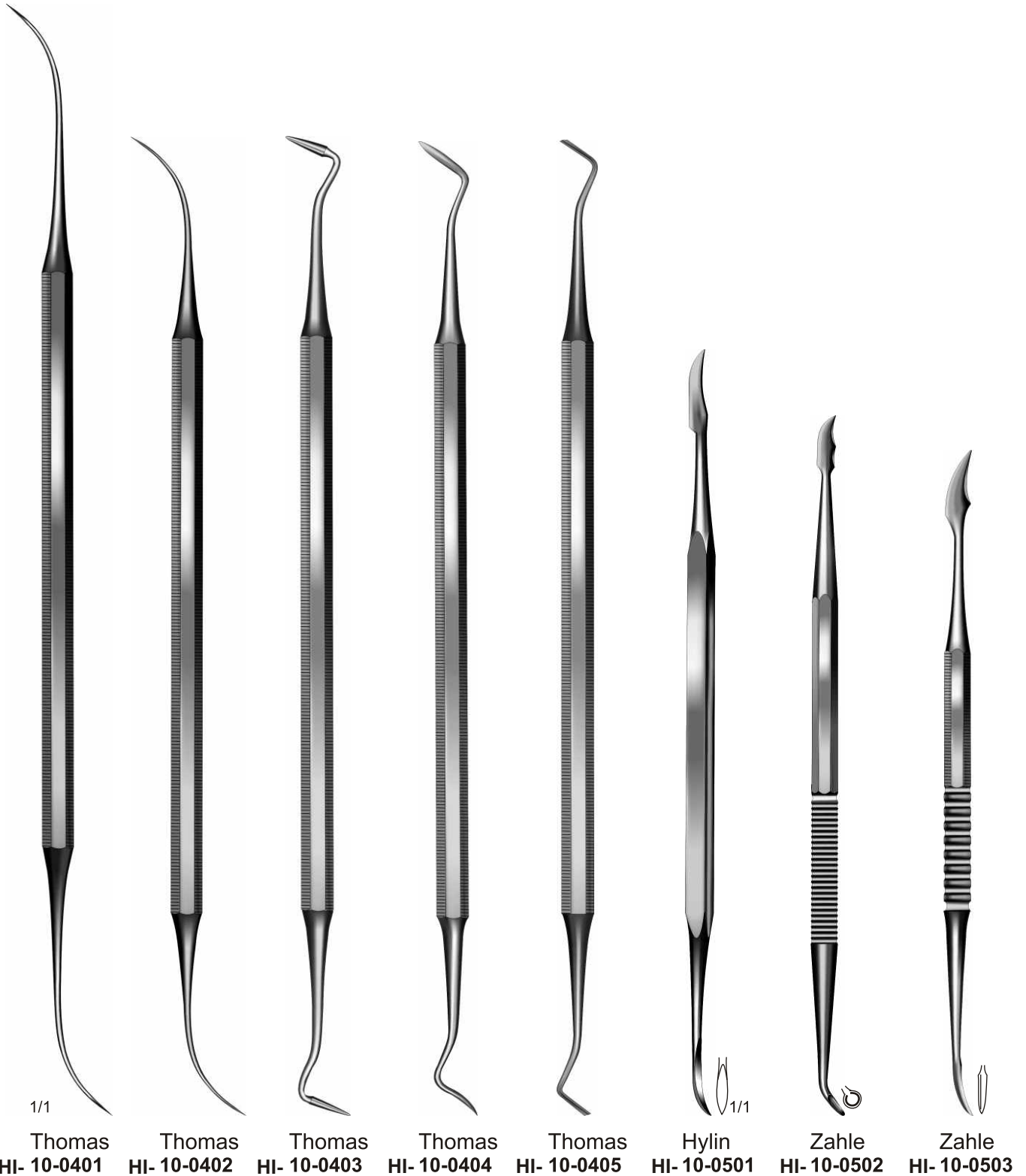



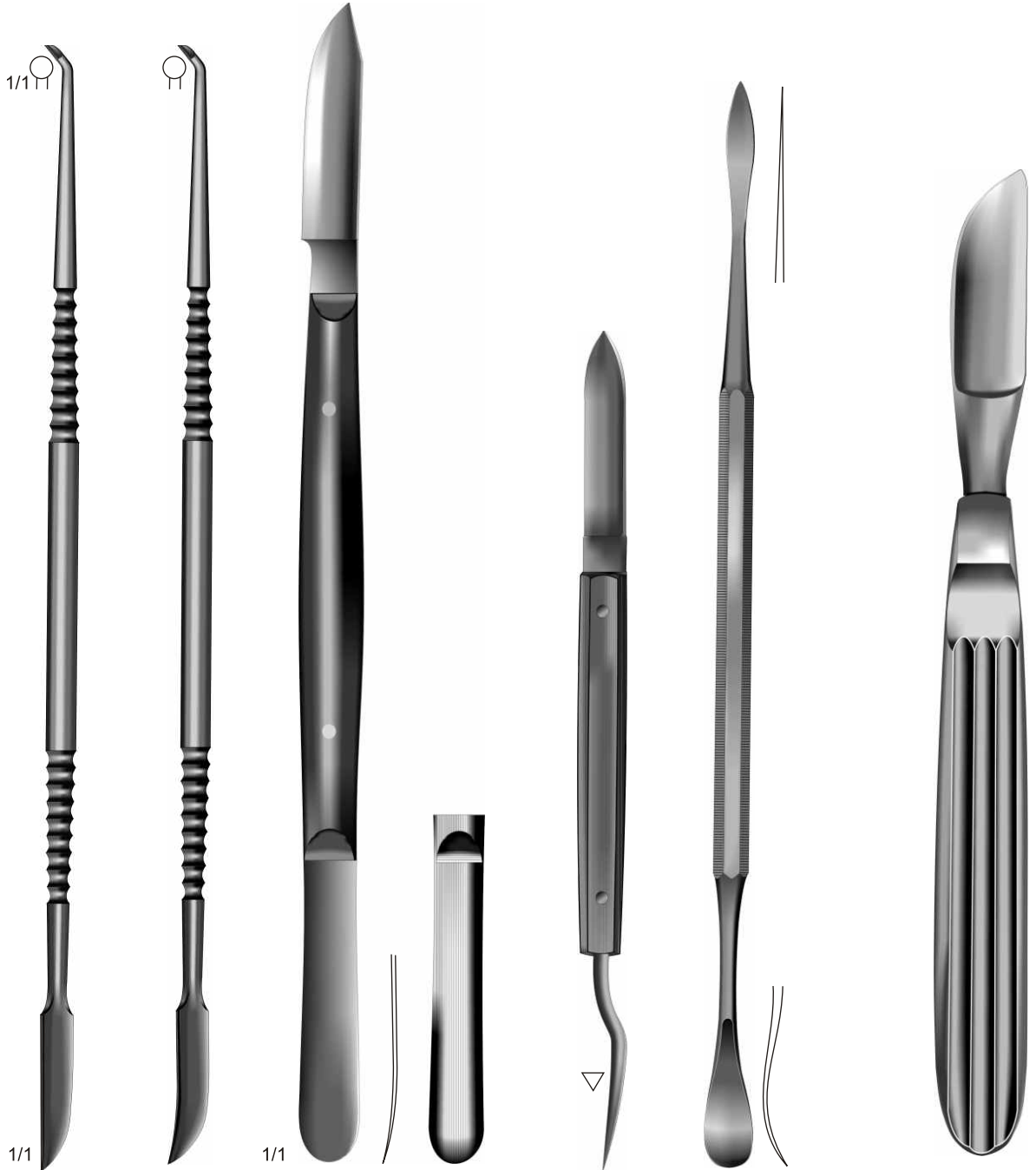

Le Cron HI- 10-0601    Le Cron HI- 10-0602

Fehnenstock  
 HI- 10-0713 - 13 cm/ 5"  
 HI- 10-0717 - 17 cm/ 6 ¾"

Ermert HI- 10-0801    Beale HI- 10-0807

Gisy-Wild HI- 10-0815



Miller  
HI- 10-0915



Sachs  
HI- 10-1001



Mershon  
HI- 10-1101



HI- 10-1201



1/1

HI- 10-1301 HI- 10-1302 HI- 10-1303 HI- 10-1304 HI- 10-1305

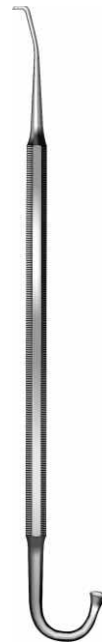

Treyemann  
HI- 10-1306



Schroeder  
**HI-10-1300**  
with interchangeable  
points 10-1301-10-1305



HI- 10-1307

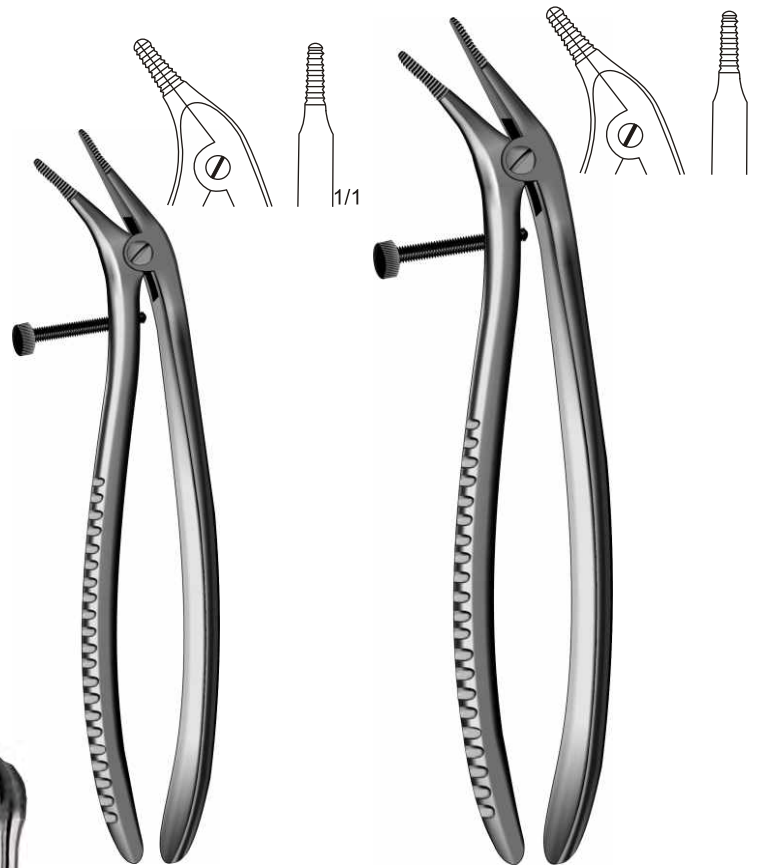

Bohm  
HI- 10-1511  
11.5 cm/ 4½"

Bohm  
HI- 10-1514  
11.5 cm/ 4½"



HI- 10-1401 HI- 10-1402 HI- 10-1403



HI-10-1401 - HI-10-1403



HI- 10-1600 HI-10-1601 HI-10-1602  
(Handle for  
HI-10-1600-HI-10-1602)



HI-10-1800

For Molars

For Molars and Premolars



1/1

Tofflemire-Universal  
HI- 10-1905



HI- 10-1907  
Fig. 7



HI- 10-1908  
Fig. 8



HI- 10-1909  
Fig. 9

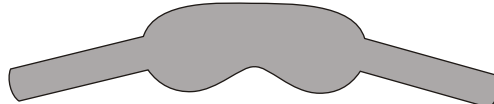

HI- 10-1910  
Fig. 10



HI- 10-1911  
Fig. 1



HI- 10-1912  
Fig. 12

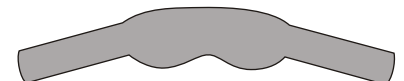

HI- 10-1913  
Fig. 13

(Package of 12 bands)



1/1

Ivory  
 HI- 10-2005 - 5 mm  
 HI- 10-2006 - 6 mm  
 HI- 10-2007 - 7 mm

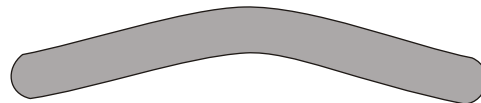

Tofflemire  
HI- 10-2101  
Fig. 1



Tofflemire  
HI- 10-2102  
Fig. 2

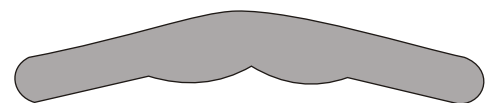

Tofflemire  
HI- 10-2103  
Fig. 3



Tofflemire  
HI- 10-2104  
Fig. 4



1/1  
**Ivory**  
**HI- 10-2201**  
 Fig. 1  
 (Without shield)



**Ivory**  
**HI- 10-2212**  
 Fig. 12  
 (With shield)



**Ivory**  
**HI- 10-2312**  
 Fig. 12 a

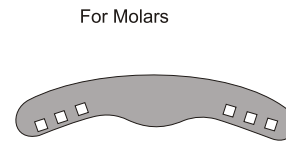

For Molars  
**HI- 10-2401**  
 Fig. 1

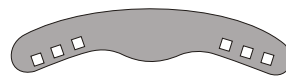

**HI- 10-2402**  
 Fig. 2



**HI- 10-2403**  
 Fig. 3

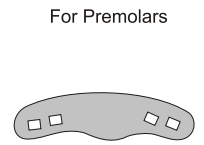

For Premolars  
**HI- 10-2404**  
 Fig. 4

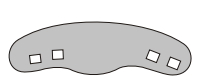

**HI- 10-2405**  
 Fig. 5



**HI- 10-2406**  
 Fig. 6

**HI-10-2401-HI-10-2403**

**HI-10-2404-HI-10-2406**



**Ainsworth**  
**HI- 10-2516**  
 16 cm/6 1/4"



**HI- 10-2515**  
 15cm/6"



**Stockes**  
**HI- 10-2617**  
 17 cm/ 6 3/4"



**Brewer**  
**HI- 10-2717**  
 17 cm/ 6 3/4"



**HI- 10-2716**  
 16 cm/6 1/4"



# CH 11

Impression Trays  
Abdrucklöffler  
Portamoldes  
Porte-empreintes  
Porta-impronte



Stainless Steel



Stainless steel “Solid” impression trays with retention rim.

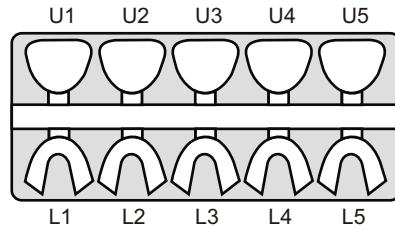

set  
**10**

Set of 10 pieces.

HI-11-2003

For Upper Jaw



		mm.	mm.
HI-11-2051- U1	XL	81	63
HI-11-2052- U2	L	74	60
HI-11-2053- U3	M	71	55
HI-11-2054- U4	NM	67	53
HI-11-2055- U5	S	65	51

For Lower Jaw



		mm.	mm.
HI-11-2061- L1	XL	80	63
HI-11-2062- L2	L	78	59
HI-11-2063- L3	M	76	57
HI-11-2064- L4	NM	72	57
HI-11-2065- L5	S	69	50

**Stainless steel “Perforated” impression trays with retention rim.**

**For Upper Jaw**

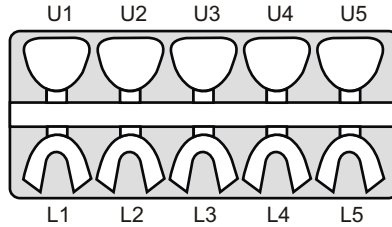

Set of 10 pieces.  
**HI-11-2103**

set  
**10**

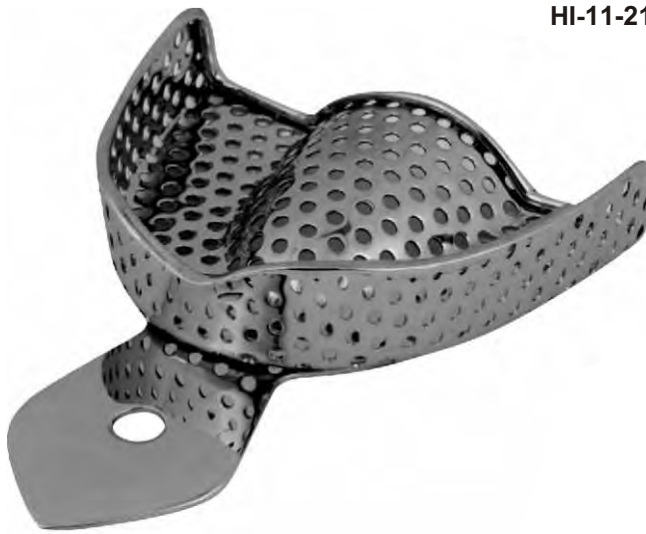
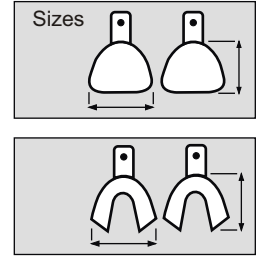

		mm.	mm.
<b>HI-11-2151- U1</b>	XL	81	63
<b>HI-11-2152- U2</b>	L	74	60
<b>HI-11-2153- U3</b>	M	71	55
<b>HI-11-2154- U4</b>	NM	67	53
<b>HI-11-2155- U5</b>	S	65	51

**For Lower Jaw**



		mm.	mm.
<b>HI-11-2161- L1</b>	XL	80	63
<b>HI-11-2162- L2</b>	L	78	59
<b>HI-11-2163- L3</b>	M	76	57
<b>HI-11-2164- L4</b>	NM	72	57
<b>HI-11-2165- L5</b>	S	69	50

Stainless Steel

**INOX**  
18/08

Stainless steel “Solid” impression trays with retention rim.

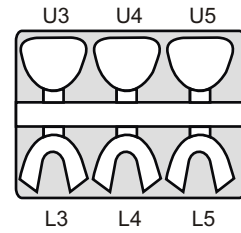

set  
**6**

Set of 6 pieces.  
**HI-11-2301**

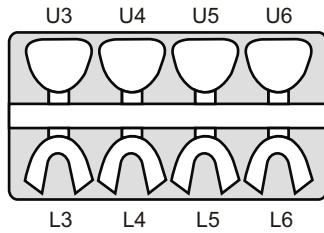

set  
**8**

Set of 8 pieces.  
**HI-11-2302**

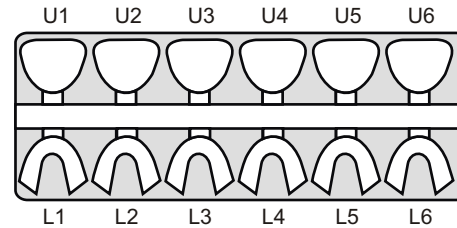

set  
**12**

Set of 12 pieces.  
**HI-11-2304**

For Upper Jaw

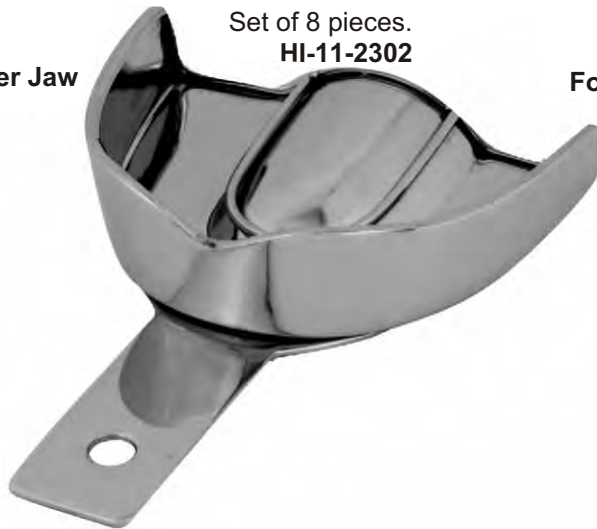

For Lower Jaw



		mm.	mm.
HI-11-2311- U1	XXS	61	47
HI-11-2312- U2	XS	64	51
HI-11-2313- U3	S	66	53
HI-11-2314- U4	M	69	57
HI-11-2315- U5	L	71	60
HI-11-2316- U6	XL	73	62

		mm.	mm.
HI-11-2331- L1	XXS	55	47
HI-11-2332- L2	XS	60	49
HI-11-2333- L3	S	72	54
HI-11-2334- L4	M	74	57
HI-11-2335- L5	L	76	59
HI-11-2336- L6	XL	78	61

Partial impression trays for crown and bridge work.



HI-11-2361- U1P



HI-11-2362- L1P



HI-11-2342- L2D  
HI-11-2344- L4D  
HI-11-2346- L6D



HI-11-2352- L2S  
HI-11-2354- L4S  
HI-11-2356- L6S

**Stainless steel "Perforated" impression trays with retention rim.**

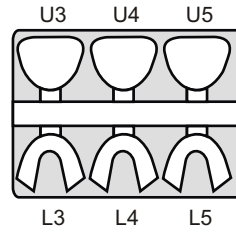

set  
**6**

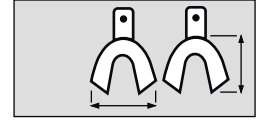
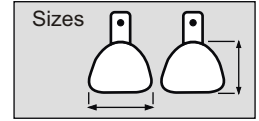

Set of 6 pieces.  
**HI-11-2401**

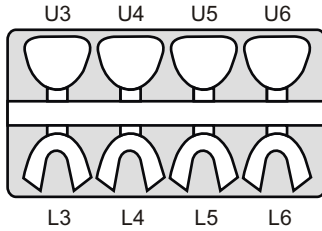

set  
**8**

Set of 8 pieces.  
**HI-11-2402**

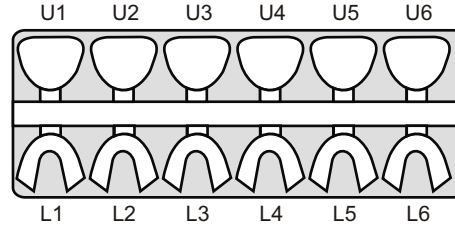

set  
**12**

Set of 12 pieces.  
**HI-11-2404**

**For Upper Jaw**

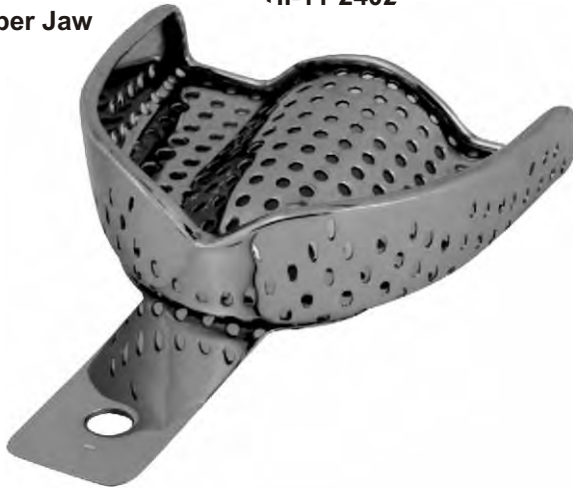

**For Lower Jaw**



		mm.	mm.
HI-11-2411- U1	XXS	61	47
HI-11-2412- U2	XS	64	51
HI-11-2413- U3	S	66	53
HI-11-2414- U4	M	69	57
HI-11-2415- U5	L	71	60
HI-11-2416- U6	XL	73	62

		mm.	mm.
HI-11-2431- L1	XXS	55	47
HI-11-2432- L2	XS	60	49
HI-11-2433- L3	S	72	54
HI-11-2434- L4	M	74	57
HI-11-2435- L5	L	76	59
HI-11-2436- L6	XL	78	61

**Partial impression trays for crown and bridge work.**



**HI-11-2461- U1P**



**HI-11-2462- L1P**



**HI-11-2442- L2D**  
**HI-11-2444- L4D**  
**HI-11-2446- L6D**



**HI-11-2452- L2S**  
**HI-11-2454- L4S**  
**HI-11-2456- L6S**



Stainless Steel

**INOX**  
18/08

Anteriorly depressed with retention rim.  
Stainless Steel "Solid"

"Solid" stainless steel

For Upper Jaw

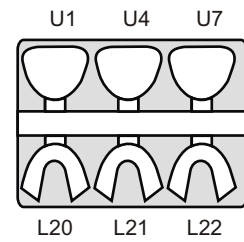

set  
**6**

Set of 6 pieces.  
**HI-11-2601**

		mm.	mm.
HI-11-2611- U1	L	81	67
HI-11-2614- U4	M	71	64
HI-11-2617- U7	S	70	57

For Lower Jaw



		mm.	mm.
HI-11-2631- L20	L	81	60
HI-11-2634- L21	M	79	57
HI-11-2637- L22	S	76	54

Anteriorly depressed with retention rim.  
 Stainless steel "Perforated"

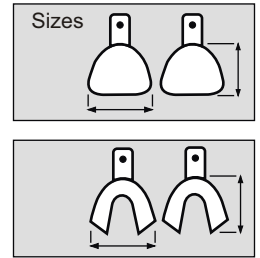

"Perforated" stainless steel

For Upper Jaw

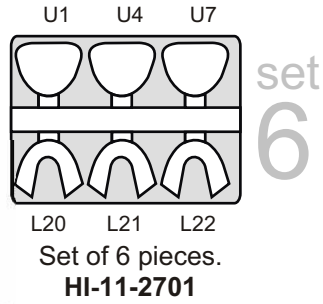
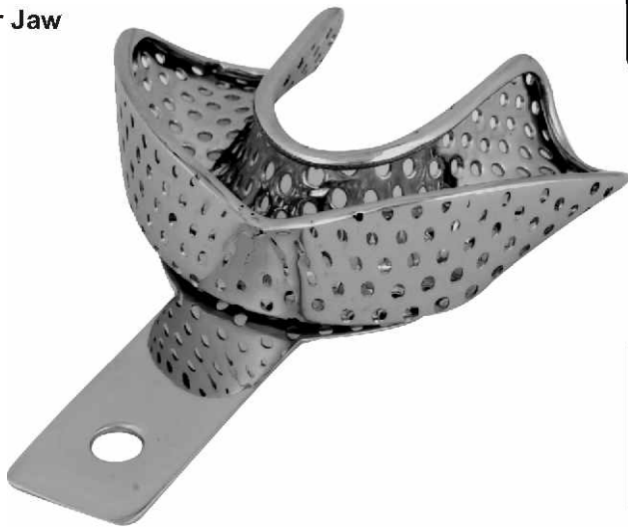

		mm.	mm.
HI-11-2711- U1	L	81	67
HI-11-2714- U4	M	71	64
HI-11-2717- U7	S	70	57

For Lower Jaw

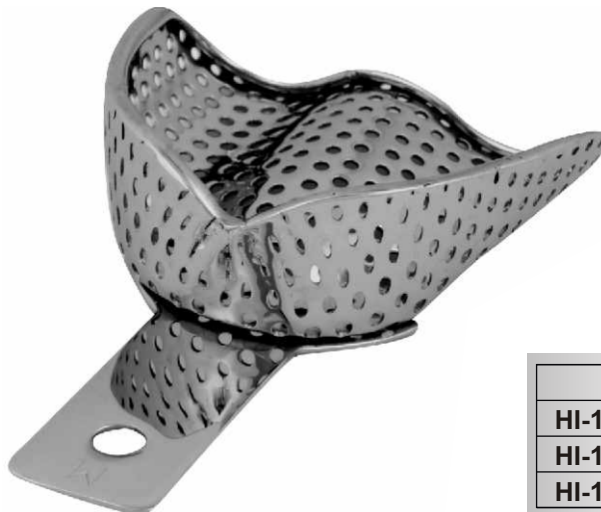

		mm.	mm.
HI-11-2731- L20	L	81	60
HI-11-2734- L21	M	79	57
HI-11-2737- L22	S	76	54

Stainless Steel

**INOX**  
18/08

Stainless steel "Solid" impression trays without retention rim.

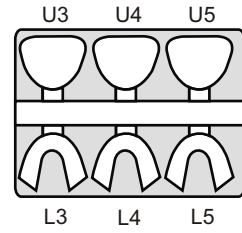

set  
**6**

Set of 6 pieces.  
**HI-11-2901**

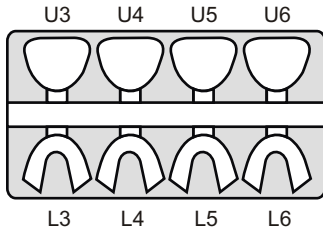

set  
**8**

Set of 8 pieces.  
**HI-11-2902**

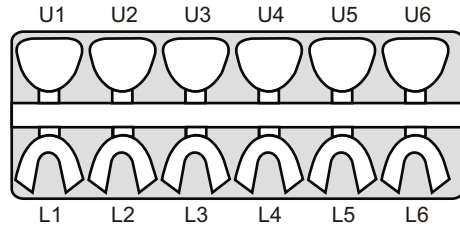

set  
**12**

Set of 12 pieces.  
**HI-11-2904**

For Upper Jaw

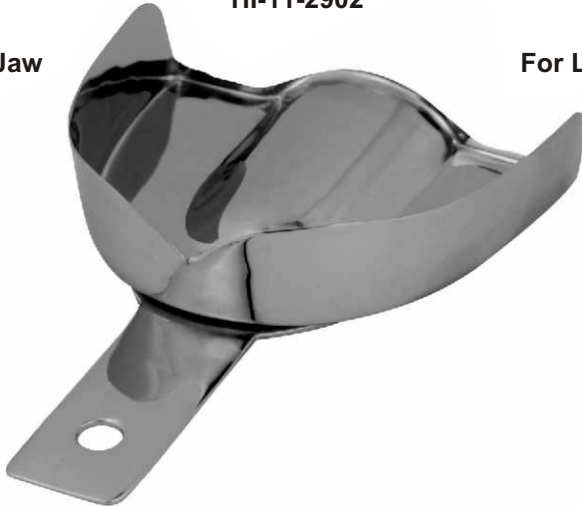

For Lower Jaw



		mm.	mm.
HI-11-2911- U1	XXS	61	47
HI-11-2912- U2	XS	64	51
HI-11-2913- U3	S	66	53
HI-11-2914- U4	M	69	57
HI-11-2915- U5	L	71	60
HI-11-2916- U6	XL	73	62

		mm.	mm.
HI-11-2931- L1	XXS	55	47
HI-11-2932- L2	XS	60	49
HI-11-2933- L3	S	72	54
HI-11-2934- L4	M	74	57
HI-11-2935- L5	L	76	59
HI-11-2936- L6	XL	78	61

Partial impression trays for crown and bridge work.



HI-11-2942- L2D  
HI-11-2944- L4D  
HI-11-2946- L6D



HI-11-2952- L2S  
HI-11-2954- L4S  
HI-11-2956- L6S

**Stainless steel “Perforated”  
 impression trays without  
 retention rim.**

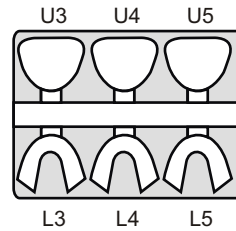

set  
6

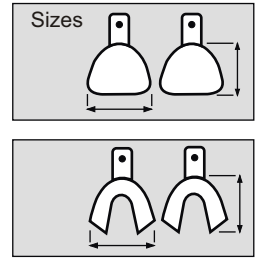

Set of 6 pieces.  
**HI-11-3101**

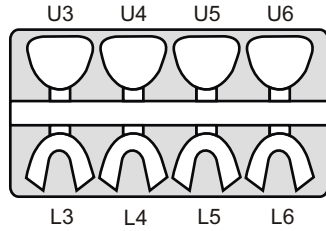

set  
8

Set of 8 pieces.  
**HI-11-3102**

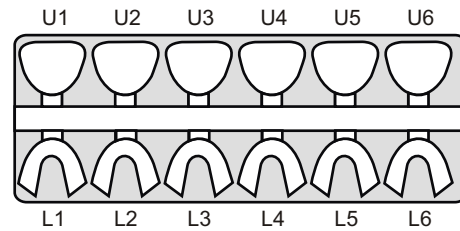

set  
12

Set of 12 pieces.  
**HI-11-3104**

For Upper Jaw

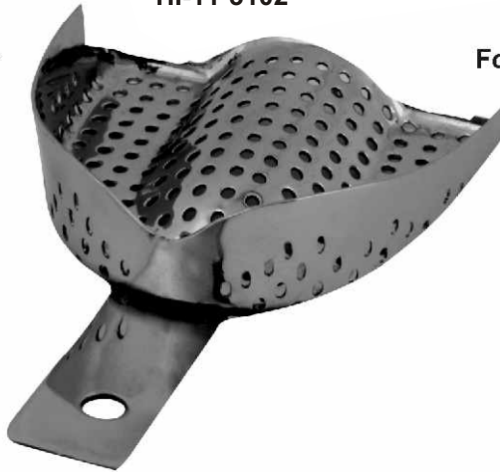

For Lower Jaw



		mm.	mm.
HI-11-3111- U1	XXS	61	47
HI-11-3112- U2	XS	64	51
HI-11-3113- U3	S	66	53
HI-11-3114- U4	M	69	57
HI-11-3115- U5	L	71	60
HI-11-3116- U6	XL	73	62

		mm.	mm.
HI-11-3131- L1	XXS	55	47
HI-11-3132- L2	XS	60	49
HI-11-3133- L3	S	72	54
HI-11-3134- L4	M	74	57
HI-11-3135- L5	L	76	59
HI-11-3136- L6	XL	78	61

**Partial impression trays for crown  
 and bridge work.**



HI-11-3142- L2D  
 HI-11-3144- L4D  
 HI-11-3146- L6D



HI-11-3152- L2S  
 HI-11-3154- L4S  
 HI-11-3156- L6S

**EHRICKE Stainless steel impression trays.**

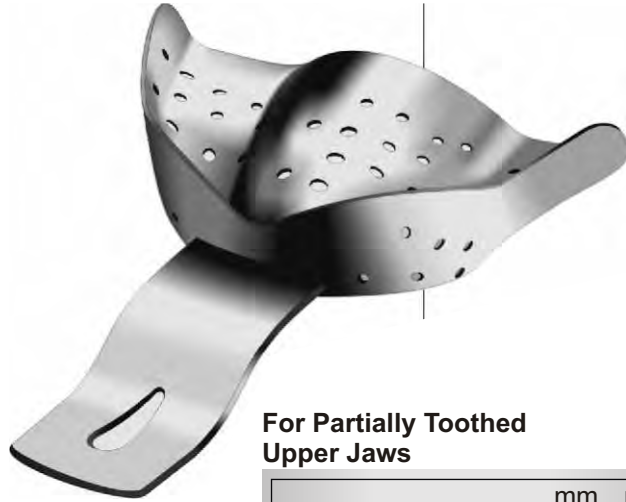
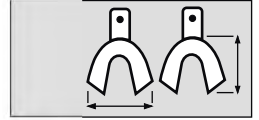
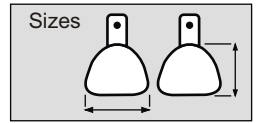

**For Partially Toothed Upper Jaws**

	mm.	mm.
HI-11-3711- Op1	62	50
HI-11-3712- Op2	70	56

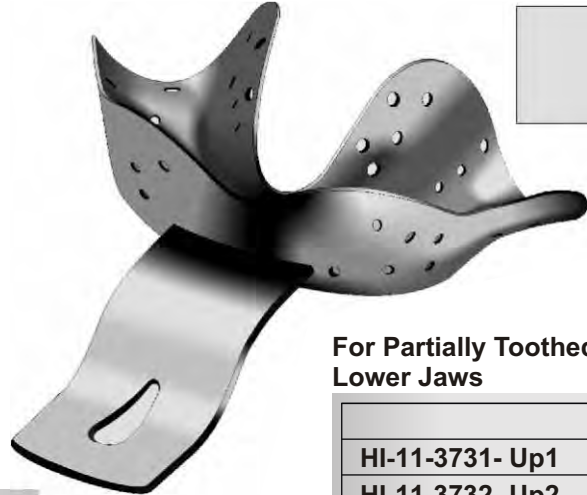

**For Partially Toothed Lower Jaws**

	mm.	mm.
HI-11-3731- Up1	70	55
HI-11-3732- Up2	78	59



**For Edentulous Upper Jaw**

	mm.	mm.
HI-11-3811- Ou1	64	46
HI-11-3814- Ou2	68	53
HI-11-3817- Ou3	79	61

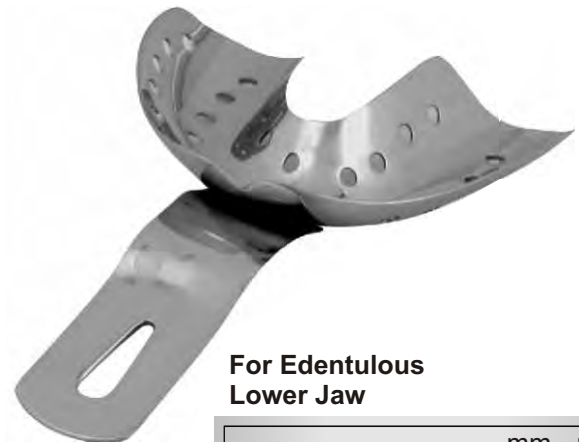

**For Edentulous Lower Jaw**

	mm.	mm.
HI-11-3831- Uu1	70	48
HI-11-3834- Uu2	70	53
HI-11-3837- Uu3	72	57

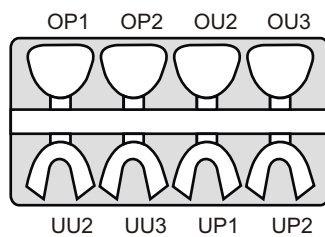

Set of 8 pieces.  
**HI-11-3702**

set  
8

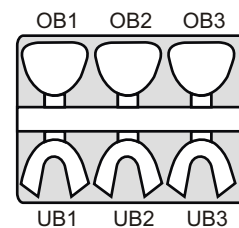

Set of 6 pieces.  
**HI-11-3801**

set  
6



# CH 12

**Pliers For Orthodontics**  
**Zangen für Kieferorthopädie**  
**Pinzas para orthodoncia**  
**Pinces pour orthodontie**  
**Pinze Ortodontiche**



**Flat Nose Pliers**

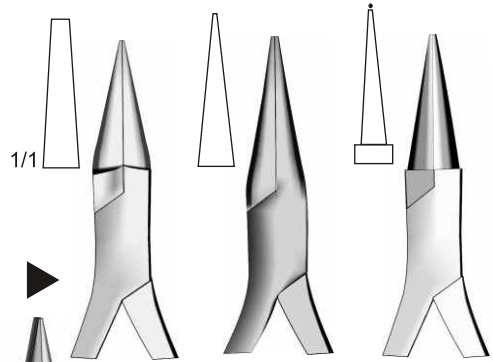

HI- 12-0111 HI- 12-0211 HI- 12-0311



Dumont  
HI-12-0111 - HI-12-0311  
12 cm/ 4 3/4"



HI-12-0414 - HI-12-0814  
14 cm/ 5 1/2"

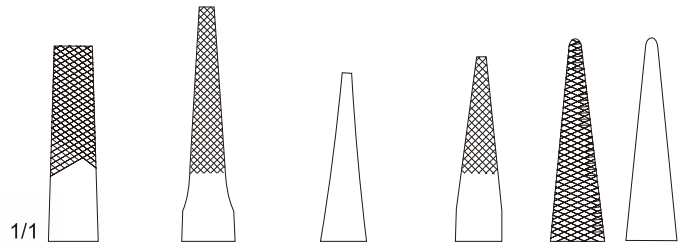

HI- 12-0414 HI- 12-0514 HI- 12-0613 HI- 12-0713 HI- 12-0814

Goslee

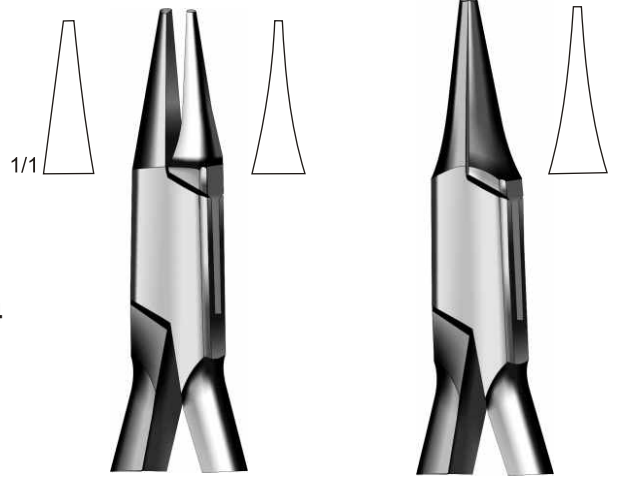

HI- 12-0915  
15 cm/ 6"

HI- 12-1013  
13 cm/ 5"

**Bending Pliers**

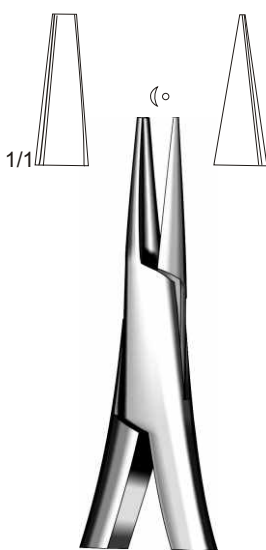

Schwarz  
HI- 12-1113  
13 cm/ 5"  
Modell I



Schwarz  
HI- 12-1213  
13 cm/ 5"  
Modell II

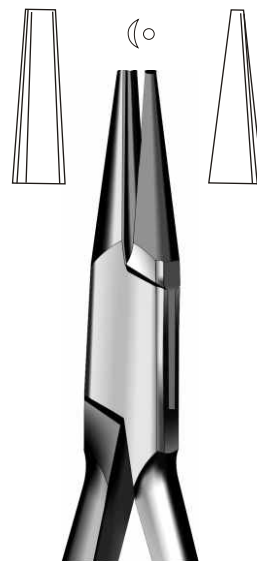

Schwarz  
HI- 12-1313  
13 cm/ 5"  
Modell III

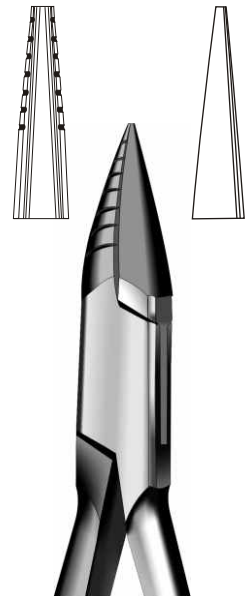

Schwarz  
HI- 12-1414  
14.5 cm/ 5 3/4"

**End and Side Nippers**



**Wire, Arch and clasp bending pliers**

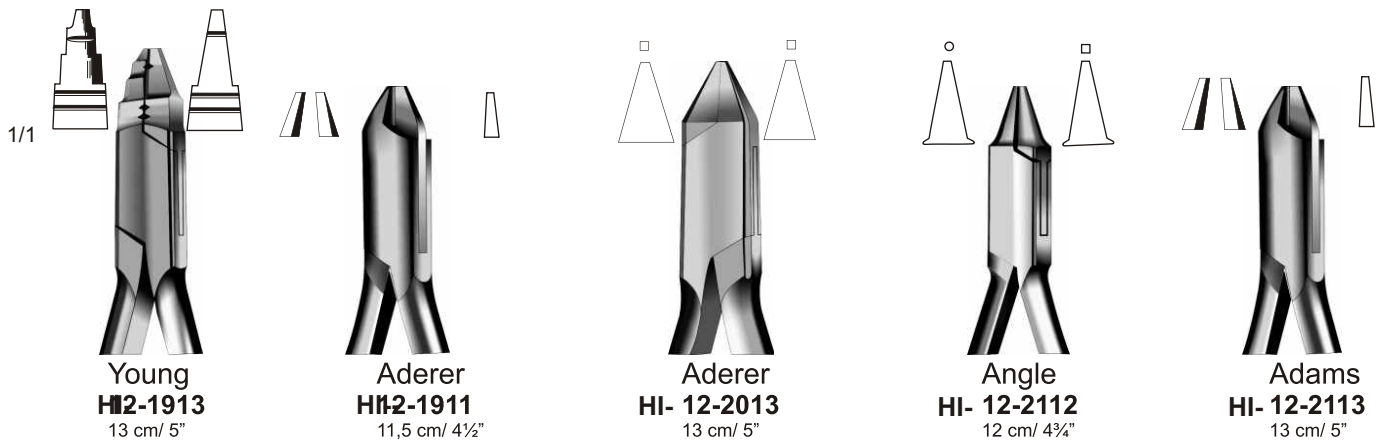

**Crown Pliers, Contouring Pliers**

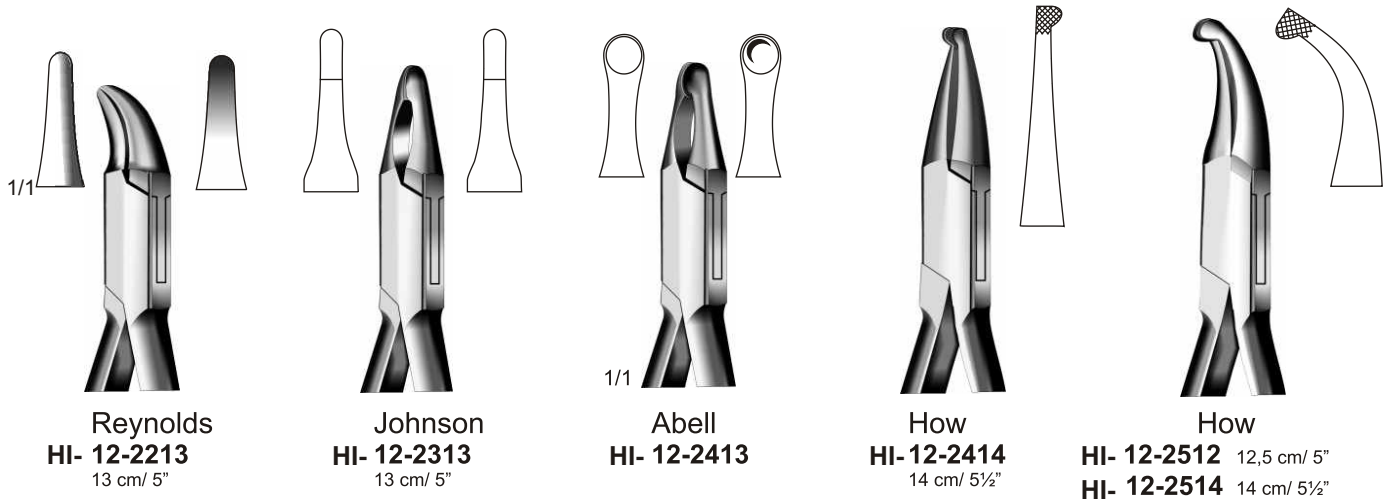

**Universal Pliers, Copper Ring and  
Bridge Removing Pliers**



Waldsachs-Universal  
**HI- 12-2615**  
15,5 cm/ 5"

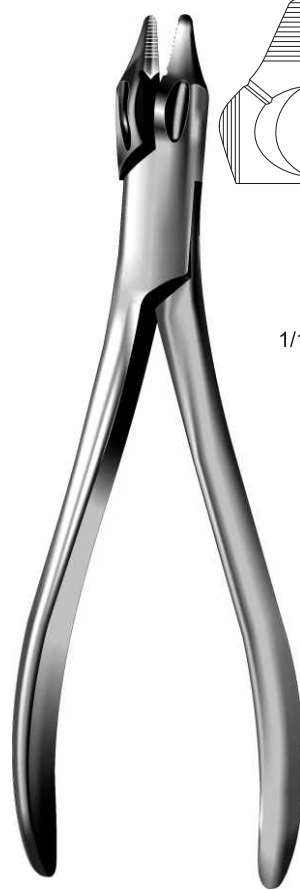
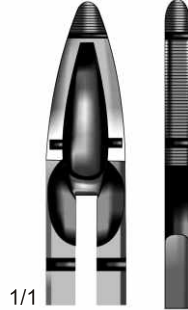

Universal  
**HI- 12-2715**  
15,5 cm/ 5"

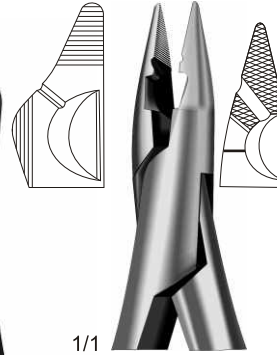

**HI- 12-2815**  
15,5 cm/ 5"



Furrer  
**HI- 12-2915**  
15,5 cm/ 5"



Lodo  
**HI- 12-3015**  
15 cm/ 5"

**Band Seating & Arch Bending Pliers**



**HI- 12-3013**  
13 cm/ 5¼"

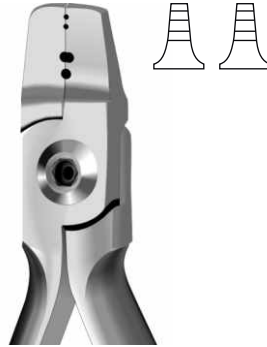

**Lingual Arch Plier**  
**HI- 12-3112**  
11.5 cm/ 4¼"  
Designed to form double and triple bends in either .030" (0.76 mm) or .036" (0.91 mm) wire for inserting lingual sheaths



**HI- 12-3212**  
12 cm/ 4¾"

Remover



**HI- 12-3213**  
13 cm/ 5"

Remover



**De La Rosa**  
**HI- 12-3312**  
11.5 cm/ 4½"  
Arch Forming & Contouring Plier  
With three grooves, for wires .016" (0.41 mm), 0.81" (0.46 mm) and .022" (0.56 mm).



**De La Rosa**  
**HI- 12-3412**  
11.5 cm/ 4½"  
Arch Forming Plier, without grooves  
Same Plier but without grooves



**D.B. Bracket Removing Plier**  
**HI- 12-3512 T/C**  
12 cm/ 4¾"  
Useful for ceramic and stainless steel brackets. The tips wedge between edge of bracket and tooth surface and remove it with ease.

Remover



**HI- 12-3612 T/C**  
12 cm/ 4¾"

Remover



**Bond Bracket**



**HI- 12-3712 T/C**  
12 cm/ 4¾"



**HI- 12-3812 T/C**  
12 cm/ 4¾"



**HI- 12-3912 T/C**  
12 cm/ 4¾"



**D.B. Bracket Removing Plier, with Pad**  
**HI- 12-4012 T/C**  
12 cm/ 4¾"  
Designed for quick and comfortable removal of direct bond brackets. It will also remove adhesive from the tooth.



**Posterior Band Removing Plier, Long**  
**HI- 12-4112 T/C**  
12 cm/ 4¾"  
Will remove band with maximum patient comfort. The tip is postured in the middle of the pad for band removal ease. A plastic padded tip and a sharp removing beak allow, with a slight pressure, easy band removal.

**Wire Bending Pliers**

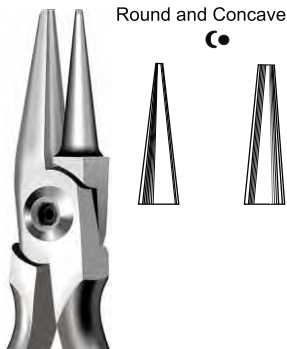

**HI- 12-4212**  
12 cm/ 4¾"  
Medium Wire Plier,  
Round & Concave Plier  
For wires up to .28" ( 0.71 mm)

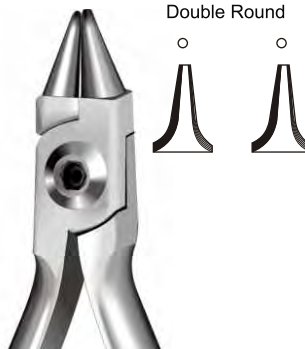

**HI- 12-4312**  
11.5 cm/ 4½"  
Double Rounded Jaw Plier  
For wires up to .030".

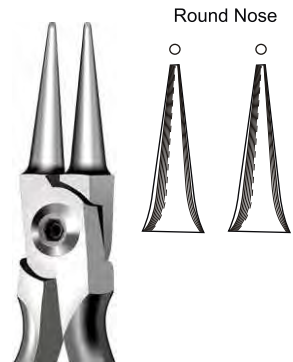

**HI- 12-4412**  
12 cm/ 4¾"

**Wire Bending Pliers**

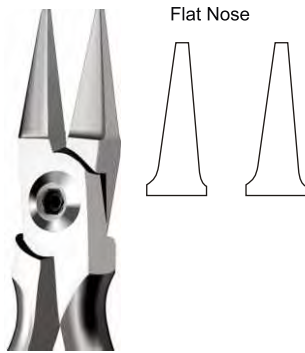

**Jarabak**  
**HI- 12-4413**  
12.5 cm/ 5"  
Excellent for precise bending of light wires. Precision grooves assure accurate bending and closing loops. Wires up to .020".

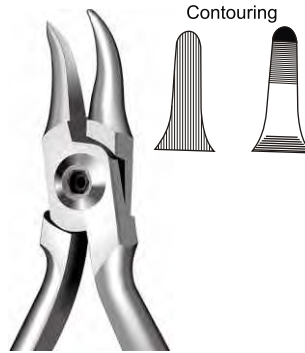

**Reynolds**  
**HI- 12-4512**  
12 cm/ 4¾"

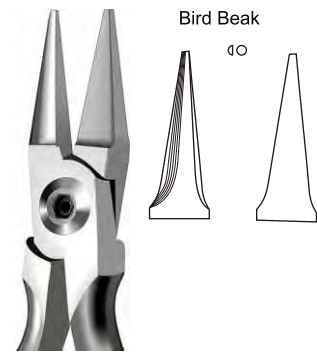

**Light Wire Plier**  
**HI- 12-4513**  
12.5 cm/ 5"  
The beaks are more tapered and longer than Angle Plier. Excellent for bending small diameter loops. Used for wires up to .016" ( 0.41 mm)

**Wire Arch Bending & Forming Pliers**



**Tweed**  
**HI- 12-4611 T/C**  
11.5 cm/ 4½"  
Rectangular Arch Pliers, Tweed Style Forming plier for square or rectangular wires. The blades are designed to be parallel at .020" ( 0.51 mm) opening. The working edges are carefully diamond-honed to prevent wire scoring.



**Tweed (Angle)**  
**HI- 12-4612 T/C**  
12 cm/ 4¾"



**Tweed (Angle)**  
**HI- 12-4711 T/C**  
11 cm/ 4½"

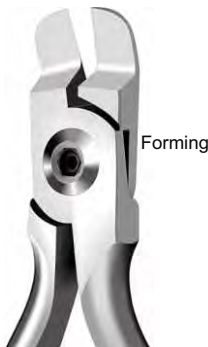

**HI- 12-4811 T/C**  
11 cm/ 4½"

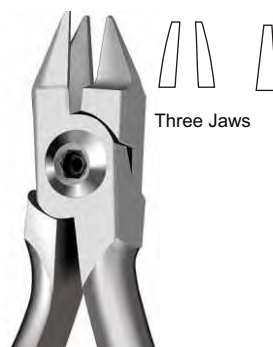

**Aderer**  
**HI- 12-4812**  
11.5 cm/ 4½"  
Three Jaw Thin Plier,  
For wires up to .028" ( 0.71 mm ).



**Aderer**  
**HI- 12-4912**  
12 cm/ 4¾"  
Three Jaw Plier, Aderer  
The precision aligned tips ensure for consistent bends. Gradually tapered for delicate bending. For wires up to 0.036" ( 0.91 mm )

### Wire Arch Bending & Forming Pliers



**How**  
**HI- 12-4913**  
13 cm/ 5¼"  
Utility Plier , How Long well tapered shape, With 3/32" ( 2.4mm) gripping pads which are serrated and shaped , so that their centre line coincides with the axis of rotation of the plier and holds the wire securely. Beaks are rounded to be completely lip safe.



**How**  
**HI- 12-5013**  
12.5 cm/ 4¾"  
Utility Plier , How Style With 1/8" ( 3.2 mm ) gripping pads, which are serrated to hold wire securely. Beaks are completely lip safe.



**Weingart**  
**HI- 12-5113 T/C**  
12.5 cm/ 4¾"  
Utility Plier, Weingart Classic design, generally utility plier. Pointed serrated tips. Holds wire firmly at convenient angle. The beaks are rounded to make the plier completely mouth safe. Useful for removal of ceramics

### Loop Forming /Bending Pliers



**Adams**  
**HI- 12-5212**  
12 cm/ 4¾"

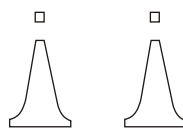

**Angle**  
**HI- 12-5312**  
11.5 cm/ 4½"  
Bird Beaks Pliers, Angle It is used for working round wires up to .030" ( 0.76 mm) in diameter. The beaks are .025" ( 0.64 mm) at the tip. The beaks are parallel at 0.20" ( 0.51 mm) opening.

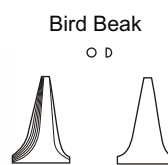

**Loop Forming /Bending Pliers**



**Mckellops Plier**  
**HI- 12-5313**  
12.5 cm/ 5¼"  
For wires up to .059" ( 1.5 mm).



Tweed Loop  
Forming



**Tweed**  
**HI- 12-5413**  
12.5 cm/ 5¼"

Loop Forming, Tweed Style Pliers Designed for making loops in round or rectangular wires up to 0.022x.0.28" ( 0.56 x 0.71 mm ). The cylindrical beak has three sections: 0.045" (1.14mm), .060" ( 1.52mm), .075" ( 1.90mm). Each section is 0.090" in length. The concave beak has slight parallel serrations which orient and keep the wire at a right angle to the beaks while the loop is being formed.



Omega Loop  
Forming



**Tweed**  
**HI- 12-5513**  
12.5 cm/ 5¼"  
Omega Loop Forming Pliers, Tweed Style  
It just differs from the Model 12-5413 in the concave beak which is rounded for making more uniform omega loops.



Single Diameter  
Loop Forming



**Tweed**  
**HI- 12-5613**  
12.5 cm/ 5¼"



**HI- 12-6612**  
Loop Closing Plier, Nance Style  
Box joint with 4 sectioned tip for forming various size loops in rectangular and round wires.  
For wires up to .028" ( 0.71 mm).

**Wire Cutting Pliers**



**HI- 12-5713 T/C**

12.5 cm/ 5"  
Hard Wire Cutter, Flat Back  
Cutting capacity up to .020 round,  
Arch wire up to .022 x .028 and all  
sizes of ligature wire and pins.



**HI- 12-5813 T/C**

12.5 cm/ 5"



**HI- 12-5913 T/C**

13 cm/ 5½"



**HI- 12-6012 T/C**

12 cm/ 5"



**HI- 12-6112 T/C**

11.5 cm/ 4½"



**HI- 12-6212 T/C**

12 cm/ 5"  
Mini cut & hold distal end cutter  
cuts with in 0.5mm from end of  
buccal tube. Use on wire up to  
0.22" x 0.28" rectangular and  
0.20" round.



**HI- 12-6312 T/C**

11.5 cm/ 4½"  
Distal End Cutter with safety hold  
It shear cuts hard wire and braided  
wire and then, safely holds the loose  
distal ends of the wire, thus preventing  
from falling down into the oral tissues.  
The cutting edges are diamond honed.  
Maximum cutting capacity: rectangular  
and twist wires up to .022 x .028"  
( 0.56 x 0.71); round wire up to .020"  
( 0.51 mm) in diameter.



## CH 13-18

- CH 13** Knives, Scalpels  
Messer, Skalpelle  
Bisturies  
Bistouris  
Bisturi
- CH 14** Scissors  
Scheren  
Tijeras  
Ciseaux  
Forbici
- CH 15** Forceps, Hemostatic Forceps  
Pinzetten, Arterienklemmen  
Pinzas hemostaticas  
Pinces, Pinces hémostatiques  
Pinzette, Pinze emostatiche
- CH 16** Needle holders  
Nadel halter  
Portaguas  
Porte-aiguilles  
Porta aghi
- CH 17** Retractors  
Wundhaken  
Separadores  
Ecarteurs  
Retrattori
- CH 18** Bone Cutting Forceps,  
Bone Rongeurs  
Hohlemeißelzangen,  
Knochen Splitterzangen  
Pinzas Cortentes para huesos  
Pinces à os coupantes,  
Pinces-gouges  
Scalpellini e pinze alveolotome





Ash  
HI-25.01  
HI-25.02



1/1  
HI-25.01  
Fig.1



HI-25.02  
Fig.2



HI-25.03  
Fig.3

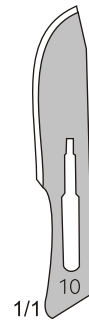

1/1  
HI-03.10  
Fig.10



HI-03.11  
Fig.11



Standard  
HI-04.03  
NO.3



HI-09.04  
NO.4



HI-06.17  
NO.7K



HI-05.07  
NO.7



HI-10.40  
NO.3  
Straight



1/1  
HI-03.12  
Fig.12



HI-03.13  
Fig.13

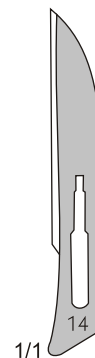

1/1  
HI-03.14  
Fig.14

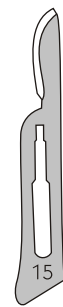

HI-03.15  
Fig.15

Operating Scissors



Standard  
**HI-14.14**  
**HI-14.64 "TC"**  
**HI-18.14**  
**HI-18.64 "TC"**  
 14,5 cm/ 5¾"  
 Blunt/ Blunt



Standard  
**HI-15.14**  
**HI-14.64 "TC"**  
**HI-18.14**  
**HI-18.64 "TC"**  
 14,5 cm/ ¾"  
 Sharp/ Sharp



Standard  
**HI-16.14**  
**HI-14.64 "TC"**  
**HI-17.14**  
**HI-17.64 "TC"**  
 14,5 cm/ 5¾"  
 Sharp/ Blunt



Metzenbaum  
**HI-36.14**  
 14,5 cm/ 5¾"



Metzenbaum  
**HI-37.14**  
 14,5 cm/ 5¾"



Metzenbaum-Delicate  
**HI-42.14** 14,5 cm/ 5¾"  
**HI-44.18** 18 cm/ 7"



Metzenbaum-Delicate  
**HI-43.14** 14,5 cm/ 5¾"  
**HI-45.18** 18 cm/ 7"



**Gum Scissors**  
 Zahnfleissscheren  
 Tijeras para encias  
 Ciseaux á gengives  
 Forbrci per gengiva



**HI-01.11**

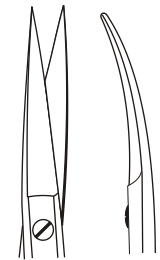

**HI-02.11**



**HI-08.90**

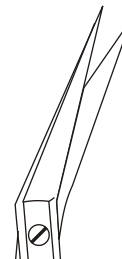

**HI-08.91**

**HI-01.11-HI-08.91**  
 11,5 cm/ 4½"

**Gum Scissors**  
Zahnfleischscheren  
Tijeras para encias  
Ciseaux à gencives  
Forbici per gengiva

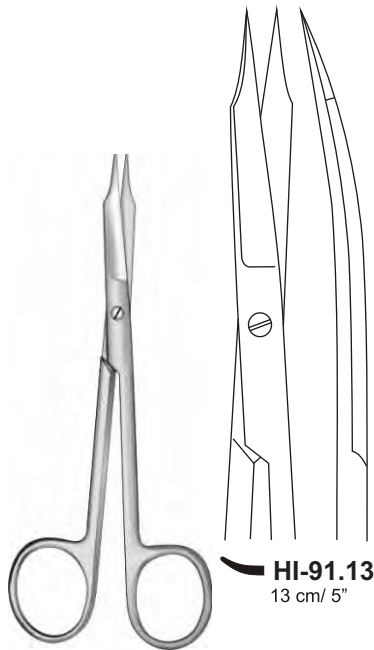

**HI-90.13**  
13 cm / 5"

**HI-91.13**  
13 cm / 5"

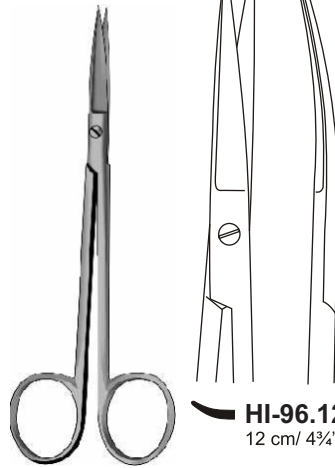

**Wagner**  
**HI-95.12**  
12 cm / 4¾"

**HI-96.12**  
12 cm / 4¾"

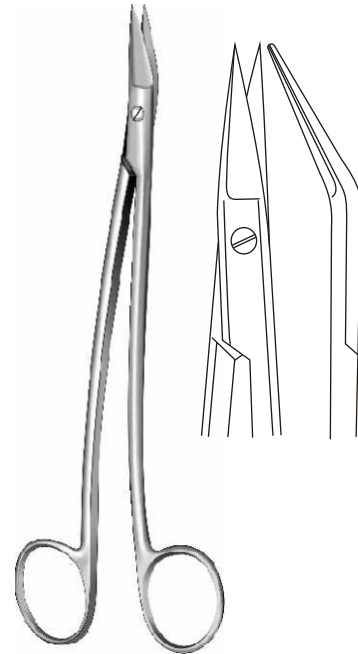

**Dean**  
**HI-25.17**  
17 cm / 6¾"



**Quinby**  
**HI-110.13**  
12,5 cm / 5"

**Quinby**  
**HI-111.13**  
12,5 cm / 5"



**La Grange**  
**HI-120.11**  
10,5 cm / 4"

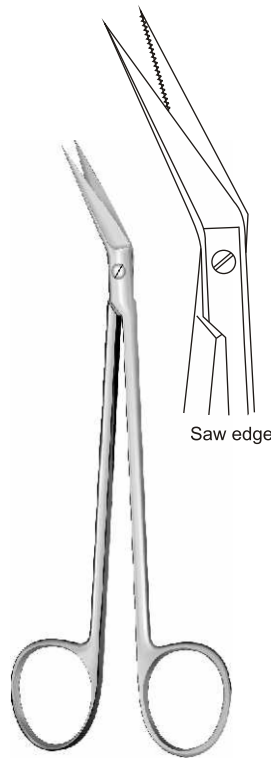

**Locklin**  
**HI-115.16**  
16 cm / 6¼"

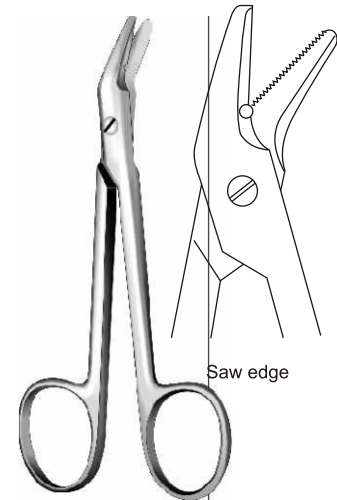

**Universal**  
**HI-23.12**  
12 cm / 4¾"

**Wire Cutting Scissors**

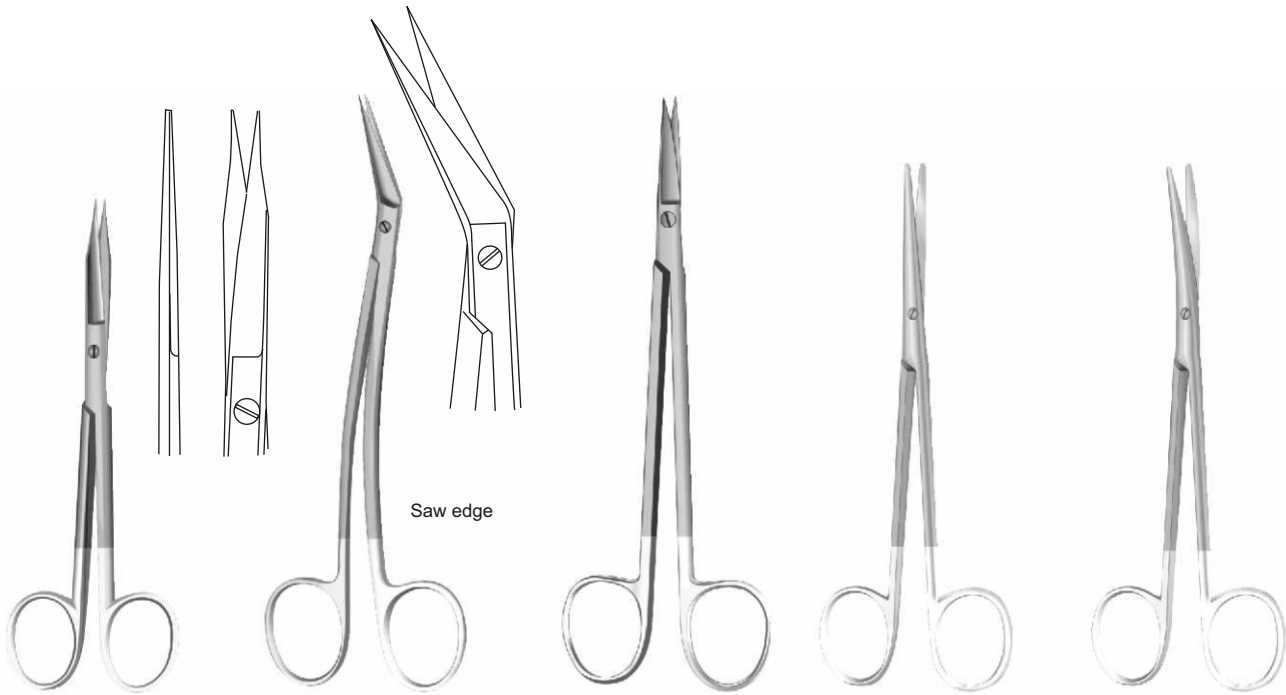

**HI-91.53**  
13 cm/ 5"

**Locklin**  
**HI-115.66**  
16 cm/ 6¼"

**Kelly**  
**HI-46.66** 16 cm/ 6¼"  
**HI-47.66** 16 cm/ 6¼"

**Metzenbaum**  
**HI- 36.64** 14 cm/ 5½"  
**HI- 37.64** 14 cm/ 5½"  
**HI- 38.70** 20 cm/ 8"  
**HI- 39.70** 20 cm/ 8"

**Metzenbaum-Fine**  
**HI- 42.64** 14 cm/ 5½"  
**HI- 43.64** 14 cm/ 5½"  
**HI- 44.70** 20 cm/ 8"  
**HI- 45.70** 20 cm/ 8"

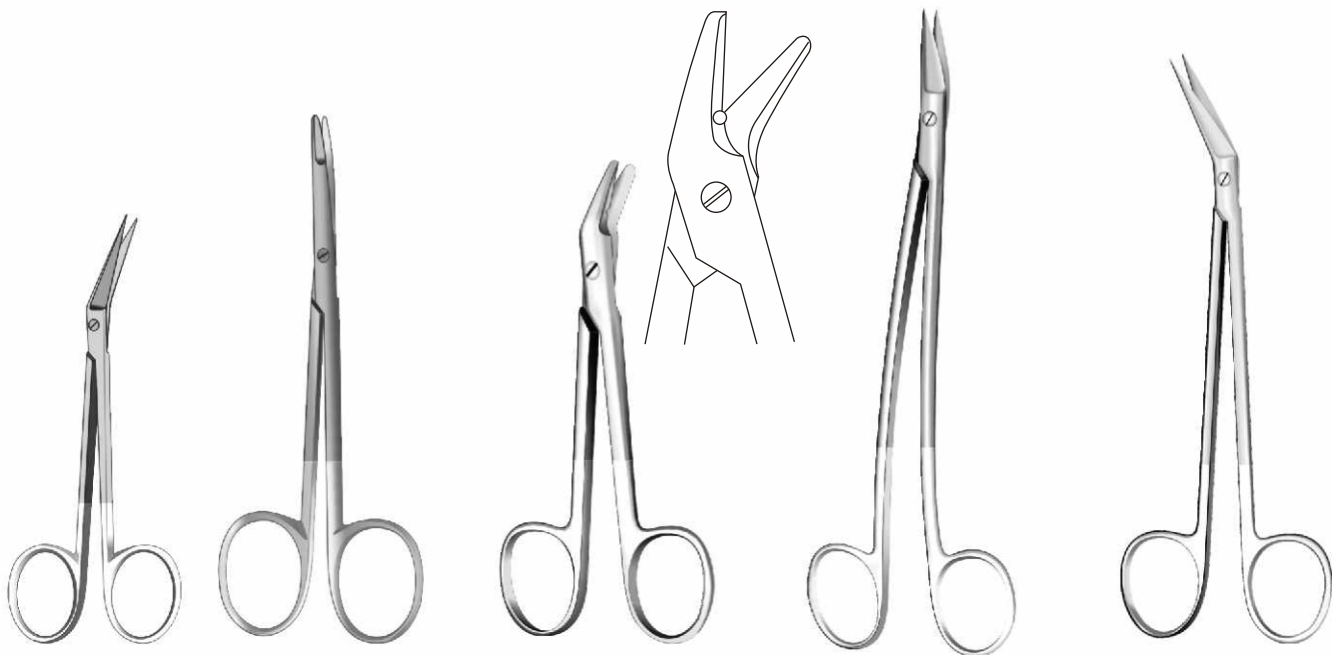

**HI- 08.92**  
11,5 cm/ 4½"

**Ragnell (Killner)**  
**HI- 59.63**  
13 cm/ 5½"

**Universal**  
**HI- 24.12**  
12 cm/ 4¾"

**Dean**  
**HI- 25.57**  
17 cm/ 6¾"

**Locklin**  
**HI- 115.66**  
16 cm/ 6¼"  
Saw Edge





1:2



Standard

Standard

Adson

Semken

Adson

Adson Brown

12 cm/ 4¾"	<b>HI- 01.11</b>	<b>HI- 05.11</b>	<b>HI- 15.12</b>
14.5cm/ 5¾"	<b>HI- 01.14</b>	<b>HI- 05.14</b>	
15cm/ 6"	<b>HI- 01.15</b>	<b>HI- 05.15</b>	<b>HI- 15.15</b>
16 cm/ 6¼"	<b>HI- 01.16</b>	<b>HI- 05.16</b>	
18 cm/ 7"	<b>HI- 01.18</b>	<b>HI- 05.18</b>	
20 cm/ 8"	<b>HI- 01.20</b>	<b>HI- 05.20</b>	
25 cm/ 10"	<b>HI- 01.25</b>	<b>HI- 05.25</b>	

**HI- 30.15**  
15.5 cm/ 6"

**HI- 16.12** 12 cm/ 4¾"  
**HI- 16.15** 15 cm/ 6" **HI- 21.12**  
**HI- 21.15**

With Tungsten Carbide "TC"



Standard "TC"

Narrow "TC"

Adson "TC"

Cushing "TC"

12 cm/ 4¾"	<b>HI- 01.62</b>	<b>HI- 03.62</b>	<b>HI- 15.62</b>	<b>HI- 52.67</b>
14.5cm/ 5¾"	<b>HI- 01.64</b>	<b>HI- 03.64</b>		17cm / 6¾"
15cm/ 6"	<b>HI- 01.65</b>		<b>HI- 15.65</b>	
16 cm/ 6¼"	<b>HI- 01.66</b>	<b>HI- 03.66</b>		
18 cm/ 7"	<b>HI- 01.68</b>	<b>HI- 03.68</b>		



FIG . 1	FIG . 2	FIG . 3	FIG . 4
<u>WOHI- 15-0915</u>	<u>HI- 15-1015</u>	<u>HI- 15-1115</u>	<u>HI- 15-1215</u>
WL HI- 15-0916	HI- 15-1016	HI- 15-1116	HI- 15-1216

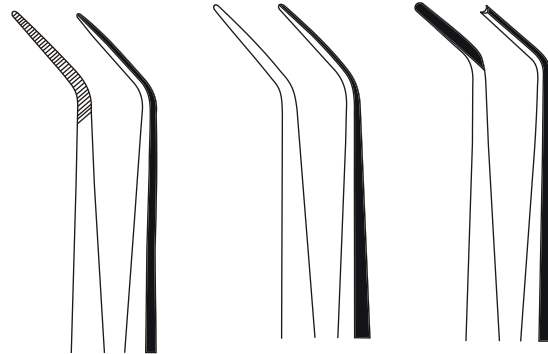

FIG . 5	FIG . 6	FIG . 7
<u>WOHI- 15-1315</u>	<u>HI- 15-1415</u>	<u>HI- 15-1515</u>
WL HI- 15-1316	HI- 15-1416	HI- 15-1516

**London College**  
15 cm/ 6"  
**HI- 15-0915 -HI-15-1515**  
WO: Without Lock  
**HI- 15-0916 -HI-15-1516**  
WL: With Lock

**Flagg**  
16 cm/ 6¼"  
**HI- 15-1616** Smooth  
**HI- 15-1626** Serrated



FIG . 1	FIG . 2	FIG . 3	FIG . 4
<u>WOHI- 15-1716</u>	<u>HI- 15-1816</u>	<u>HI- 15-1916</u>	<u>HI- 15-2016</u>
WL HI- 15-1717	HI- 15-1817	HI- 15-1917	HI- 15-2017

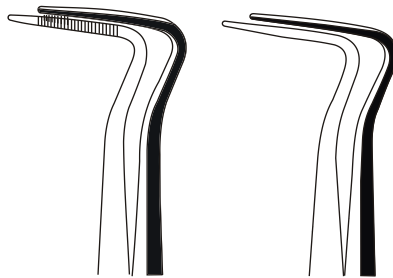
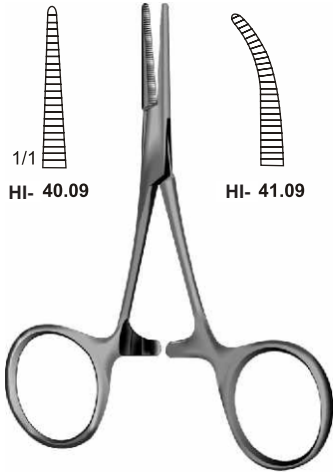

FIG . 5	FIG . 6
<u>WO HI- 15-2116</u>	<u>HI- 15-2216</u>
WL HI- 15-2117	HI- 15-2217

**Meriam**  
16 cm/ 6¼"  
**HI- 15-1716 -HI-15-2216**  
WO: Without Lock  
**HI- 15-1717 -HI-15-2217**  
WL: With Lock

**Perry**  
13 cm/ 5"  
**HI- 15-2410** Serrated  
**HI- 15-2413** Smooth





1/1  
HI- 40.09

HI- 41.09

**Hartmann**

**HI- 40.09 - HI- 41.09**

10 cm/4"      10 cm/4"  
Straight      Curved

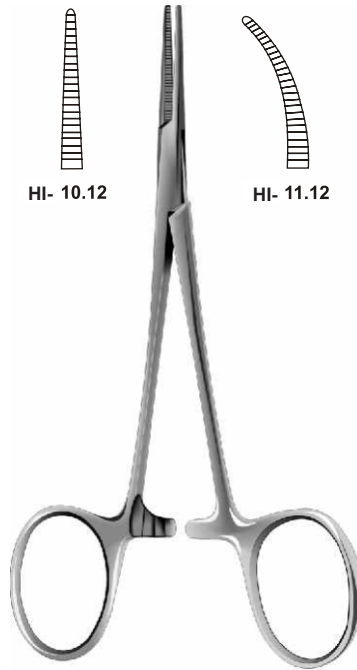

HI- 10.12

HI- 11.12

**Halstead**

**HI- 10.12 - HI- 11.12**

12 cm/4 3/4"      12 cm/4 3/4"  
Straight      Curved

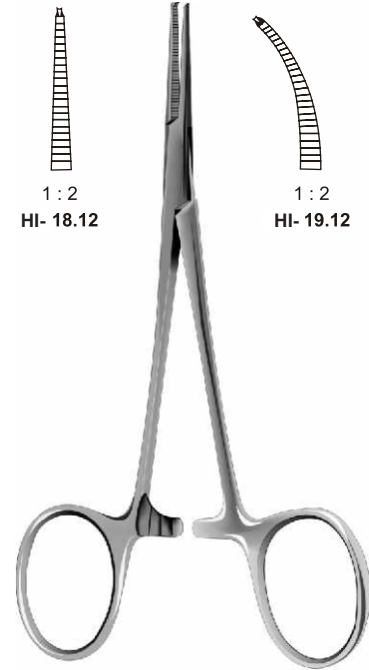

1 : 2  
HI- 18.12

1 : 2  
HI- 19.12

**Halsted-Mosquito**

**HI- 18.12 - HI- 19.12**

12,5 cm/5"      12 cm/5"  
Straight      Curved



**Jones**

**HI- 19.06** 6 cm/ 2 1/2"  
**HI- 20.09** 9 cm/ 3 1/2"



**Backhaus**

**HI- 25.08** 8 cm/ 3 1/4"  
**HI- 25.10** 11 cm/ 4 1/2"  
**HI- 26.13** 13 cm/ 5"

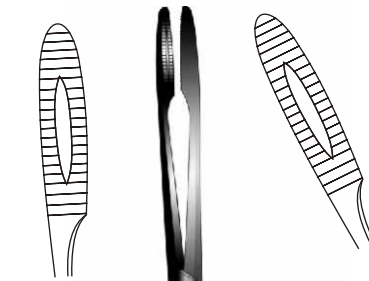

HI- 11.20  
HI- 13.26

HI- 12.20  
HI- 14.26

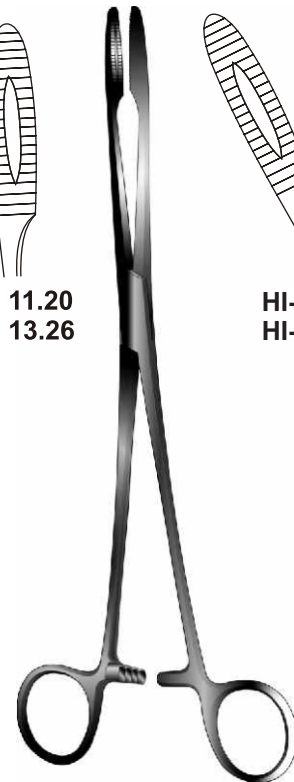

**Gross-Maier**

**HI- 11.20 - HI- 13.26**  
**HI- 12.20 - HI- 14.26**  
20cm/ 8"      26cm/ 10 1/4"

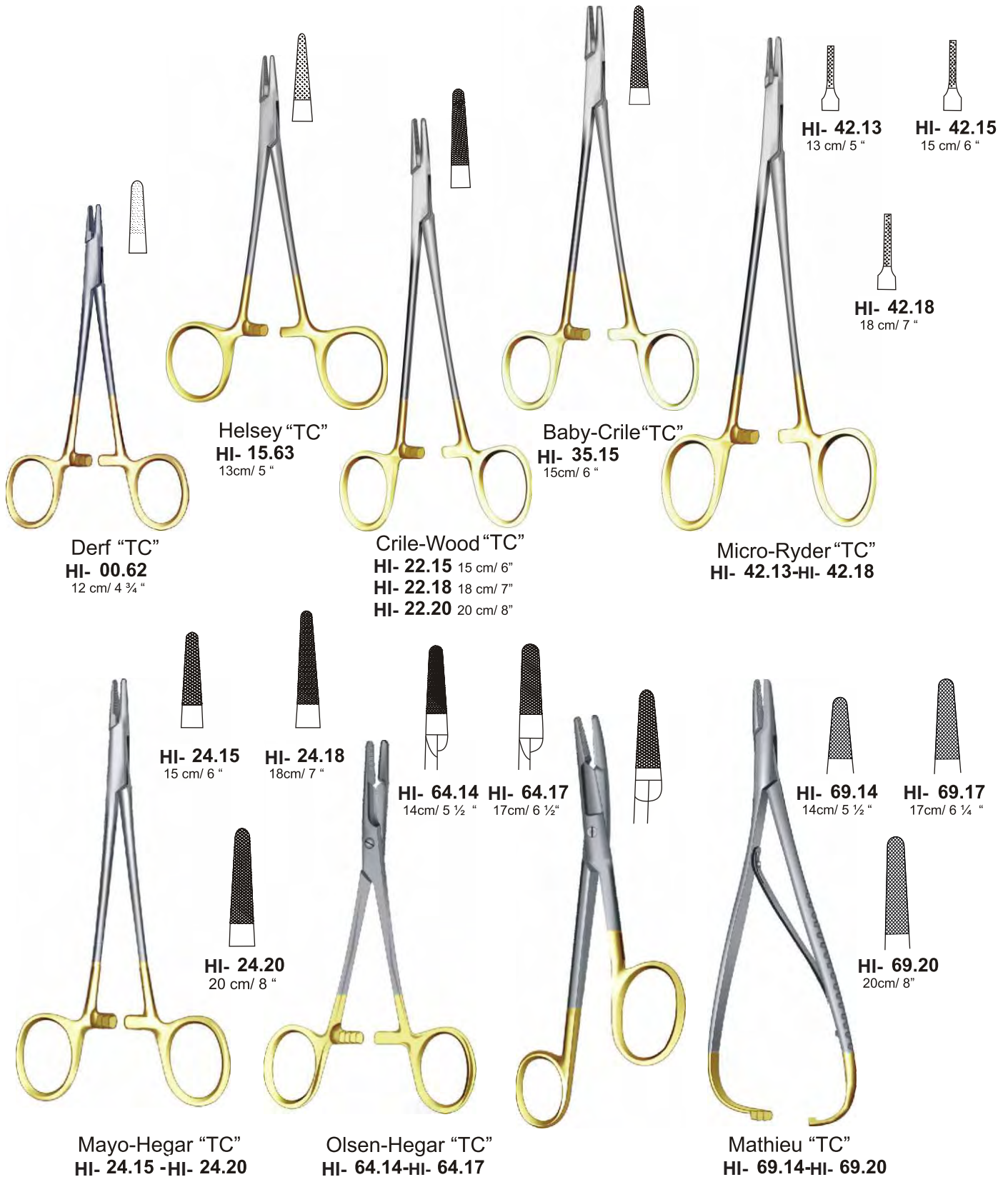



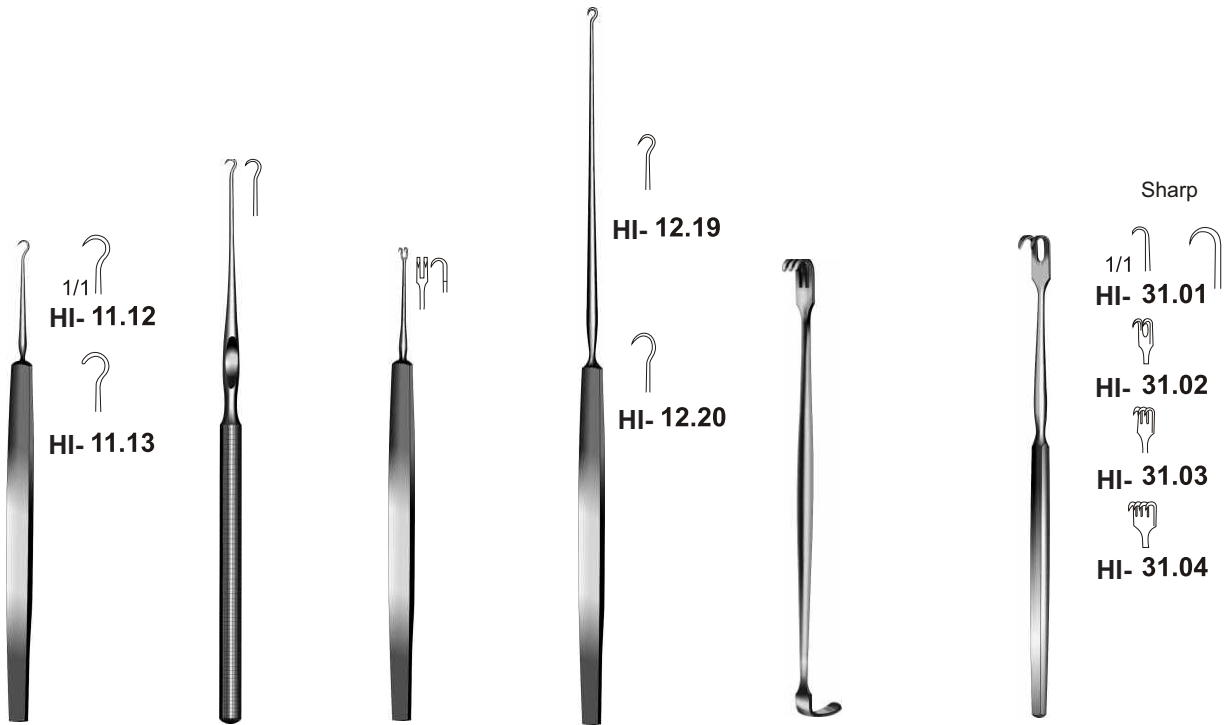

Frazier  
HI- 11.12-  
HI- 11.13  
13 cm/ 5 ¼"

Kilner  
HI- 11.15  
15 cm/ 6"

Guthrie  
HI- 25.13  
13 cm/ 5"

Gillies  
HI- 12.19-  
HI- 12.20  
19 cm/ 7"

Senn-Miller  
HI- 01.16  
16 cm/ 6¼"

HI- 31.01 -  
HI- 31.04  
16 cm/ 6¼"

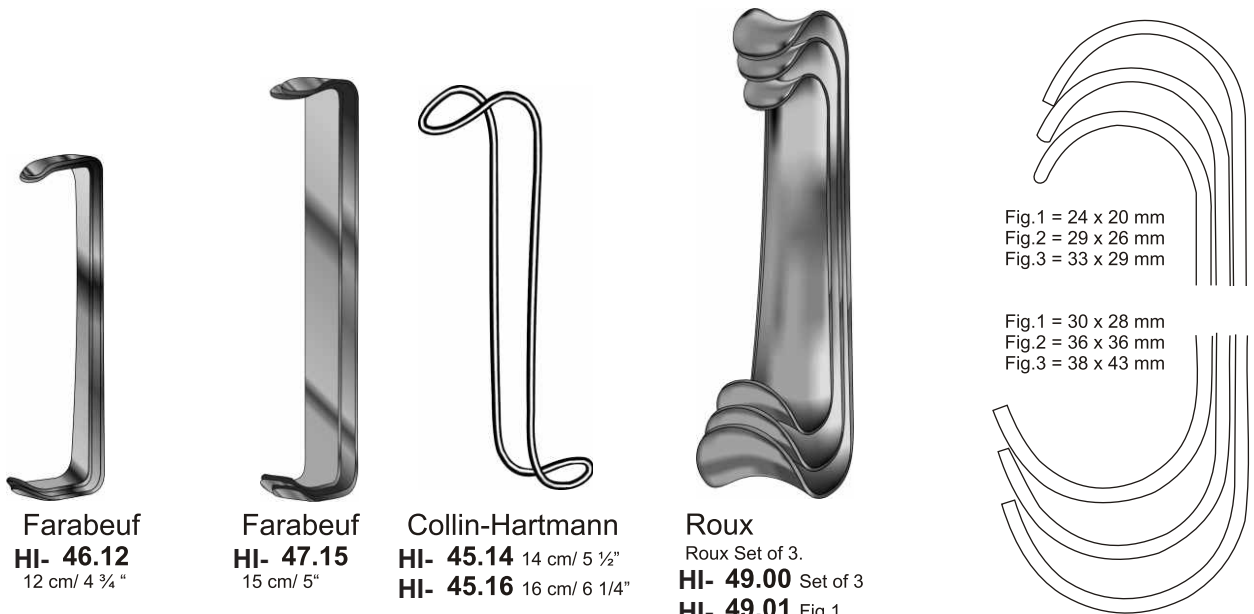

Farabeuf  
HI- 46.12  
12 cm/ 4 ¾"

Farabeuf  
HI- 47.15  
15 cm/ 5"

Collin-Hartmann  
HI- 45.14 14 cm/ 5 ½"  
HI- 45.16 16 cm/ 6 ¼"

Roux  
Roux Set of 3.  
HI- 49.00 Set of 3  
HI- 49.01 Fig.1  
HI- 49.02 Fig.2  
HI- 49.03 Fig.3

Fig.1 = 24 x 20 mm  
Fig.2 = 29 x 26 mm  
Fig.3 = 33 x 29 mm

Fig.1 = 30 x 28 mm  
Fig.2 = 36 x 36 mm  
Fig.3 = 38 x 43 mm

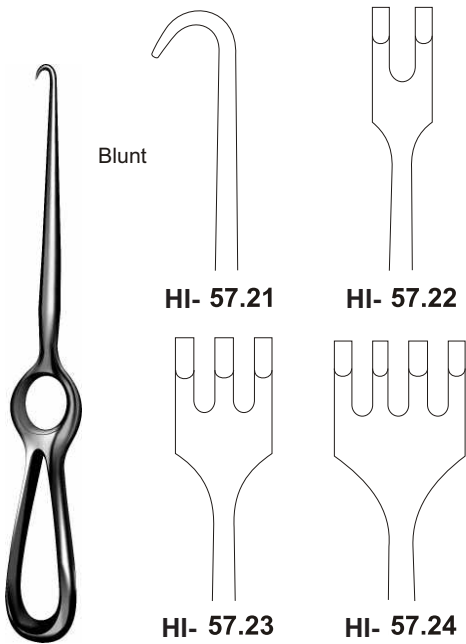

Volkmann  
HI- 57.21-HI- 57.24  
21.5 cm/ 8 1/2"

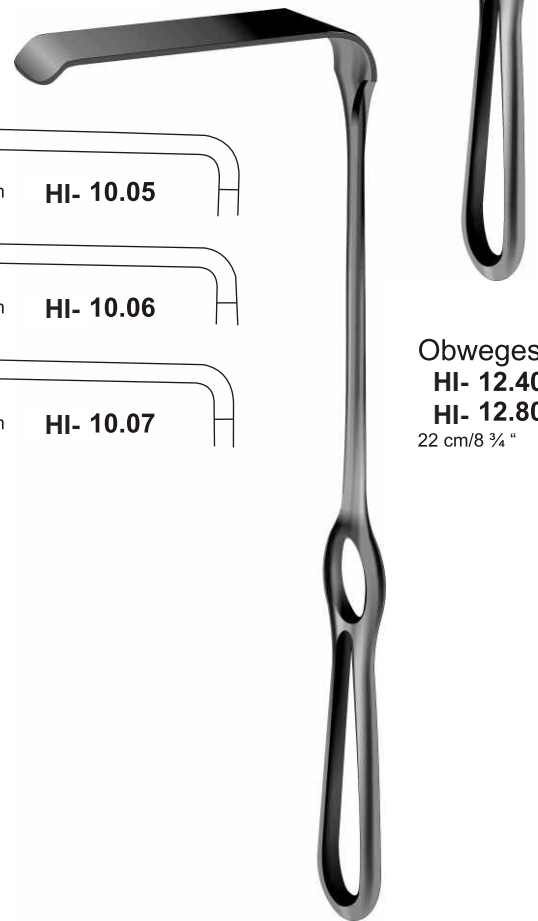
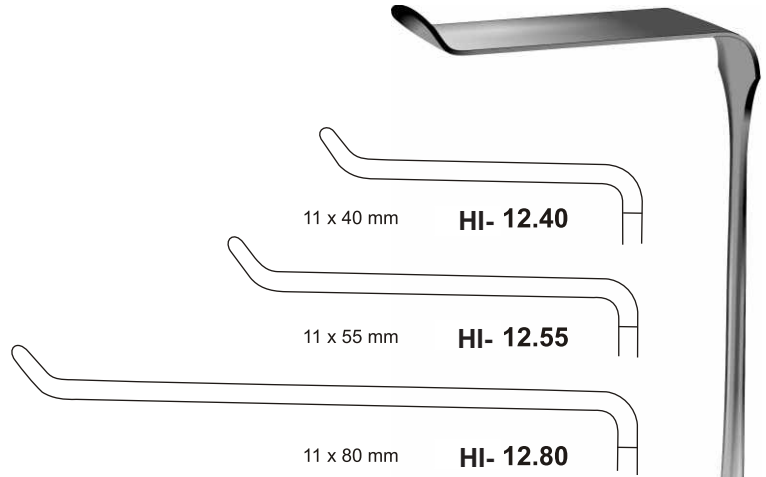

Obwegeser  
HI- 12.40-  
HI- 12.80  
22 cm/8 3/4 "

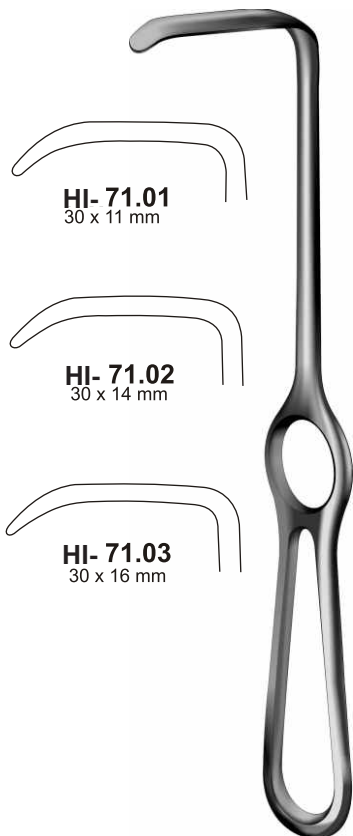

Langenbeck  
HI- 71.01-HI- 71.03  
21cm/ 8 1/4 "

Obwegeser  
HI- 10.05 -  
HI- 10.07  
21,5 cm/8 1/2 "



Williger  
**HI- 11.17**  
17 cm/6 ¾"



Williger  
**HI- 12.04**  
16 cm/6 ¼"



Freer  
**HI- 28.21**  
21.5 cm/ 8 ½"



**HI- 19.20**  
17,5 cm/7"



Molt  
**HI- 19.21**  
19 cm/7 ½"

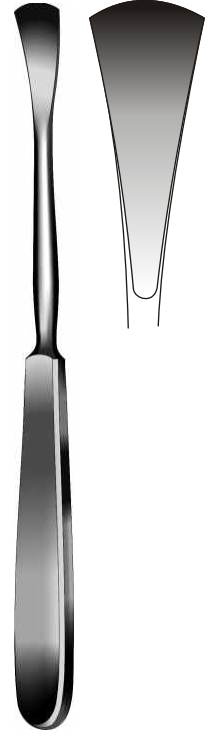

Lengenbeck  
**HI- 37.35**  
19 cm/7 ½"

Bone Nibblers.



1mm  
HI- 37.01  
2mm  
HI- 37.02  
3mm  
HI- 37.03

Citelli  
**HI- 37.01-**  
**HI- 37.03**  
17 cm/6 ¾"

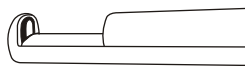

4 x 4 mm  
HI- 36.01  
5 x 5 mm  
HI- 36.02  
6 x 6 mm  
HI- 36.03



Kerrison  
**HI- 36.01-**  
**HI- 36.03**



Friedman  
**HI- 01.14**  
14 cm/5 ½"



**Cleveland**  
**HI- 04.14**  
14 cm/5 1/2"

**Cleveland 4A**  
**HI- 04.17**  
17 cm/6 3/4"

**Luer**  
**HI- 20.65**  
15 cm/6"

**Luer**  
**HI- 20.75**  
15 cm/6"

**Bohler**  
**HI- 32.01-HI- 32.02**  
15 cm/6"

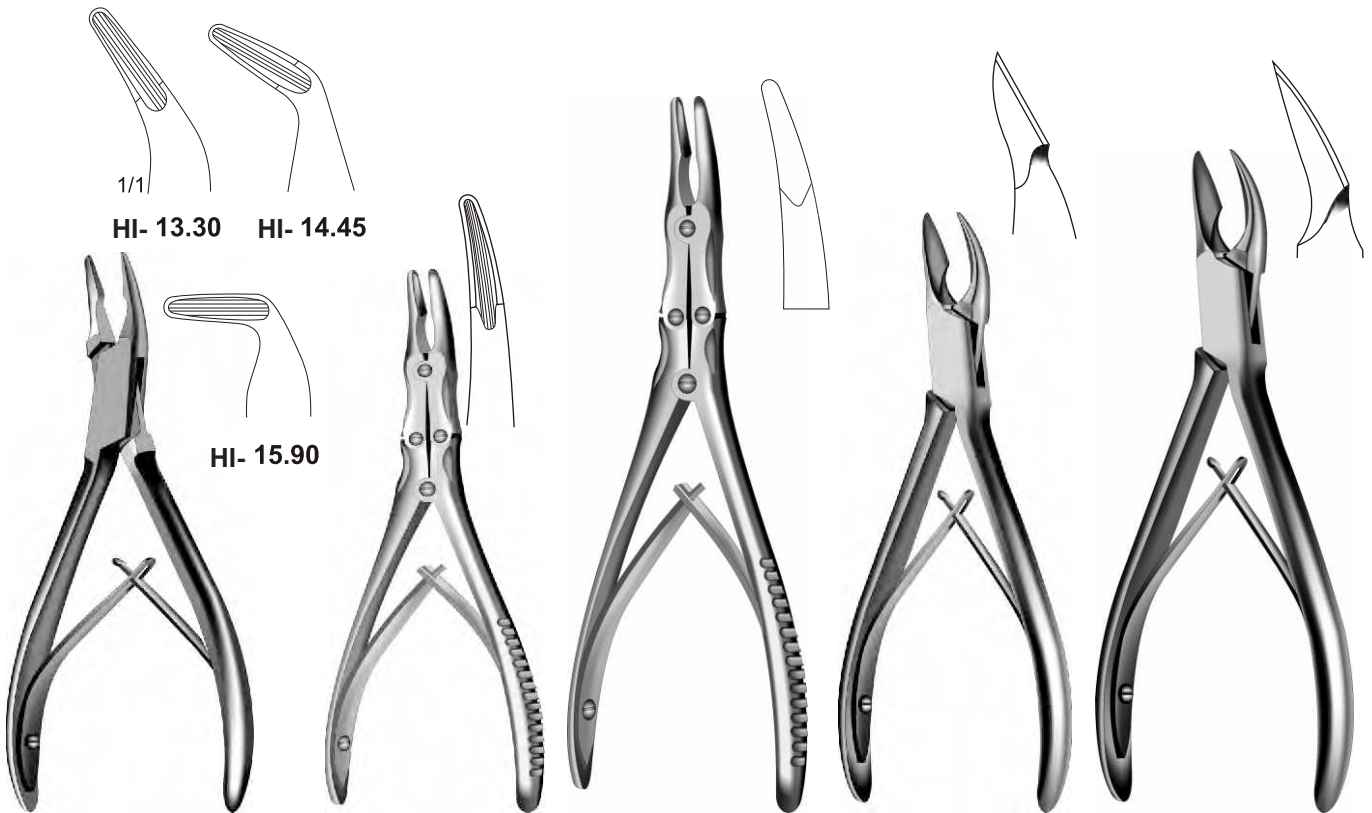

**Blumenthal**  
**HI- 13.30-**  
**HI- 15.90**  
16 cm/6"

**Beyer**  
**HI- 31.16**  
15,5 cm/6"

**Beyer**  
**HI- 31.18**  
18 cm/7"

**Cleveland 5 S**  
**HI- 04.14**  
14cm/5 1/2"

**Cleveland 5**  
**HI- 05.17**  
17 cm/6 3/4"

- 2 mm ○ HI- 10.62
- 3 mm ○ HI- 10.63
- 4 mm ○ HI- 10.64
- 5 mm ○ HI- 10.65
- 6 mm ○ HI- 10.66
- 7 mm ○ HI- 10.67
- 8 mm ○ HI- 10.68



**Keys**  
 HI- 10.62-  
 HI- 10.68



**Farrell** Ø 0.9 mm  
 HI- 16.12 12 cm/ 4 ¾"  
 HI- 16.14 14 cm/ 5 ½"  
 HI- 16.16 16 cm/ 6 ¼"



**Bowmann**  
 HI- 94.00  
 Set of 4  
 HI- 94.01 Fig 1+2  
 HI- 94.03 Fig 3+4  
 HI- 94.05 Fig 5+6  
 HI- 94.07 Fig 7+8



Ø 1.5 mm	Ø 2 mm	
HI- 01.10	HI- 02.10	11 cm/ 4 ¼"
HI- 01.13	HI- 02.13	13 cm/ 5"
HI- 01.14	HI- 02.14	14 cm/ 5 ½"
HI- 01.16	HI- 02.16	16 cm/ 6 ¼"

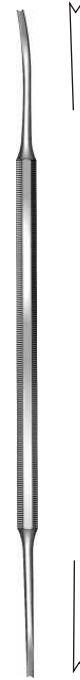

**Luniatchek**  
 HI- 30.19  
 19 cm/7 ½"



**Luniatchek**  
 HI- 30.20  
 19 cm/7 ½"



**Sternberg**  
 HI- 03.15  
 14 cm/5 ½"

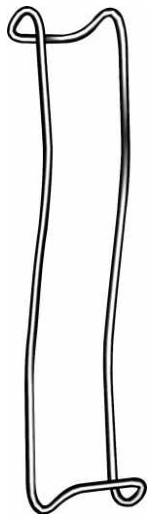

**Sternberg**  
 HI- 03.16  
 16 cm/6 ¼"



**Bruenings**  
 HI- 05.18  
 19 cm/7 ½"



**HI- 03.16**  
 Wood  
 16 cm/ 6 ¼"



**Kroenig**  
 HI- 03.14  
 15 cm/6"



**Mayo**  
 HI- 04.17  
 17 cm/6 ¼"



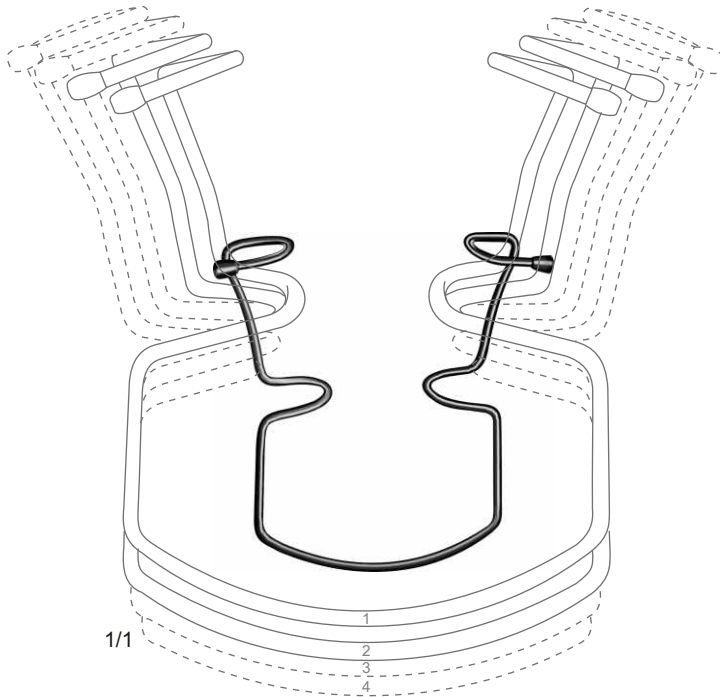

**Oringer**

- HI- 01.00 Fig.1
- HI- 01.02 Fig.2
- HI- 01.03 Fig.3
- HI- 01.04 Fig.4
- HI- 01.13 Set of 4

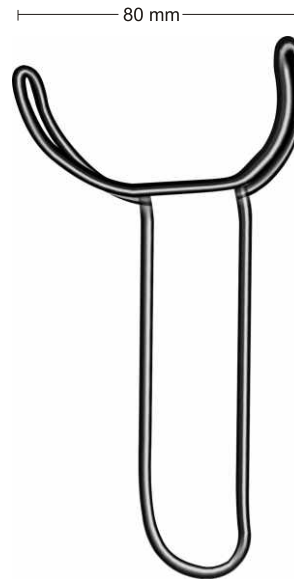

**Vestibelum-Haken**

- HI- 01.15
- 15cm/ 6"



**Heister**

- HI- 05.05
- 13 cm/ 5"

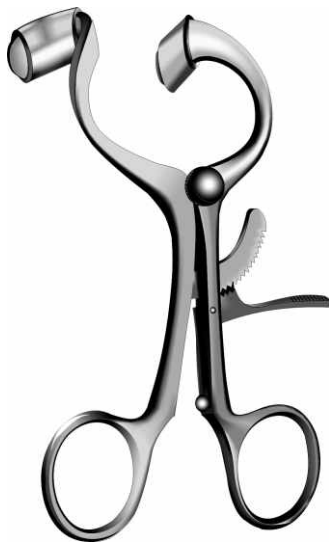

**Molt**

- HI- 07.15
- 15cm/6"



**Jennings**

- HI- 09.09 9 cm/ 3 1/2"
- HI- 09.11 11 cm/ 4 1/4"
- HI- 09.13 13 cm/ 5"
- HI- 09.15 15 cm/ 6"



**Roser-Konig**

- HI- 13.45 16 cm/6 1/4"
- HI- 13.50 20 cm/7 1/2"

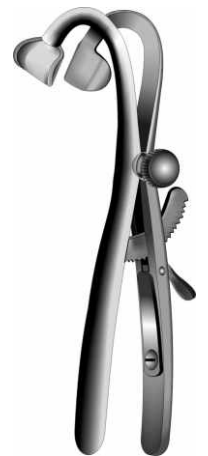

**Denhart**

- HI- 14.60
- 13 cm/5"

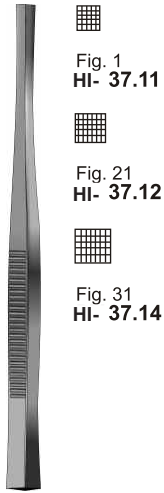

Fig. 1  
HI- 37.11  
Fig. 21  
HI- 37.12  
Fig. 31  
HI- 37.14

Passow  
HI- 37.11-  
HI- 37.14  
12 cm/ 4 3/4 "



Partsch  
13,5 cm/5 1/2 "



Partsch  
13,5 cm/5 1/2 "

	13,5 cm/5 1/2 "	17 cm/6 3/4 "	13,5 cm/5 1/2 "	17 cm/6 3/4 "
3 mm	HI- 05.03	HI- 05.53	HI- 06.03	HI- 06.53
4 mm	HI- 05.04	HI- 05.54	HI- 06.04	HI- 06.54
5 mm	HI- 05.05	HI- 05.55	HI- 06.05	HI- 06.55
6 mm	HI- 05.06	HI- 05.56	HI- 06.06	HI- 06.56



Cottle  
HI- 28.04  
HI- 28.12



- HI- 14.24 Fig.0000
- HI- 14.33 Fig.000
- HI- 14.42 Fig.00
- HI- 14.50 Fig.0
- HI- 14.51 Fig.1
- HI- 14.52 Fig.2
- HI- 14.53 Fig.3
- HI- 14.54 Fig.4
- HI- 14.55 Fig.5
- HI- 14.56 Fig.6



Volkmann  
HI- 14.22- HI- 14.56  
17 cm/6 3/4 "

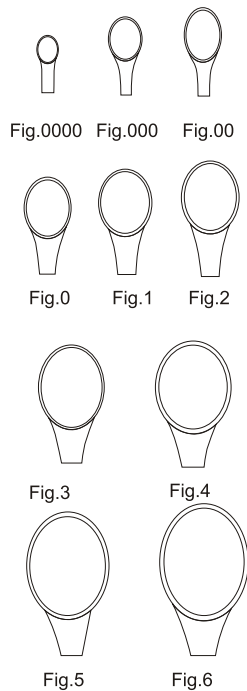

Williger  
HI- 21.10  
HI- 21.12  
13,5 cm/5 1/4 "

- HI- 21.10
- HI- 21.11
- HI- 21.12



Partsch  
HI- 30.15  
15 cm/6 "  
Fig. 1



Partsch  
HI- 31.15  
15 cm/6 "  
Fig. 2

**Bone Curettes and Mallets**

Scharte Iffel und Hämmer

Curetas (Cucharillas) Cortantes y Martillos y Mazos

Curettes tranchantes et maillets

Cucchiaini per osso e martelli

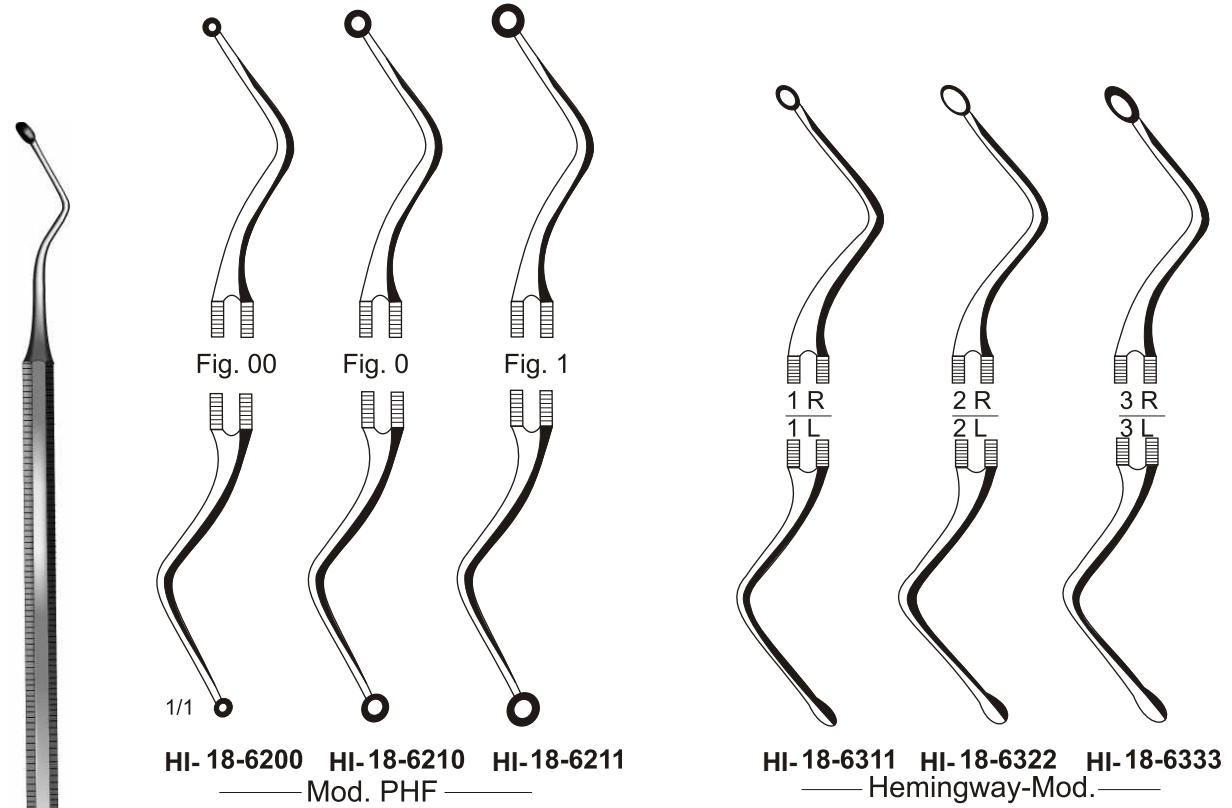

HI-18-6200 - HI-18-6211  
HI-18-6311 - HI-18-6333



HI- 01.16  
16,5 cm/ 6 ½"



Collin  
HI- 05.20  
20 cm/ 8"

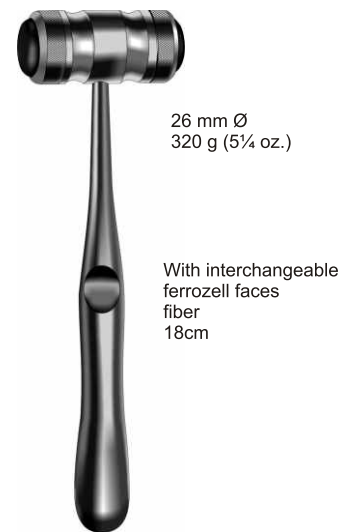

Mead  
HI- 06.19  
Massive - solid  
17 cm/ 6 ¾"

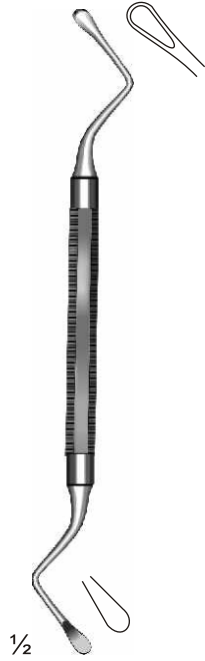

Miller-Colburn  
HI-18-6411 - HI-18-6444



HI-18-6411

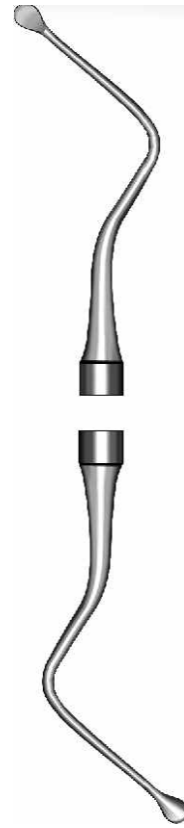

HI-18-6422



HI-18-6433

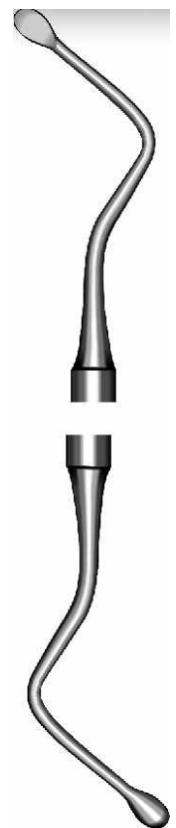

HI-18-6444

Miller-Colburn

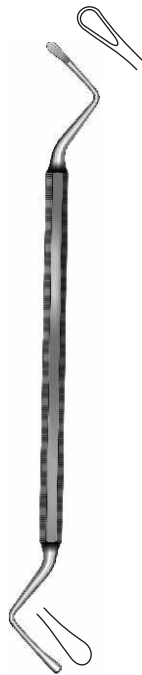

HI-18-6401

Lucas  
HI-18-6501 -HI-18-6504



HI-18-6501

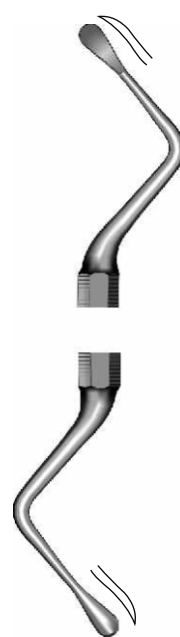

HI-18-6502



HI-18-6503

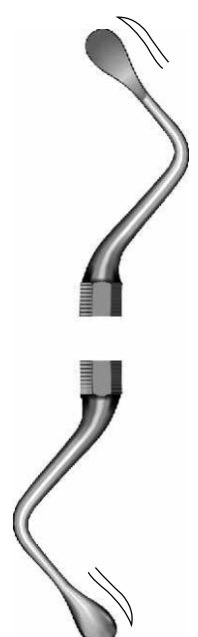

HI-18-6504

Lucas

**Tongue Depressors / Mouth Gags / Tongue Holding forceps**

Zungenspatel / Mundsperrer / Zungenzengen

Bajaleguas / Abrebocas / Pinzas ira lengne

Ecarteurs des levres / Ouvre-bouches / Pinces tire langue

Spatola per lingua / Apribocca / Pinza tira lingua

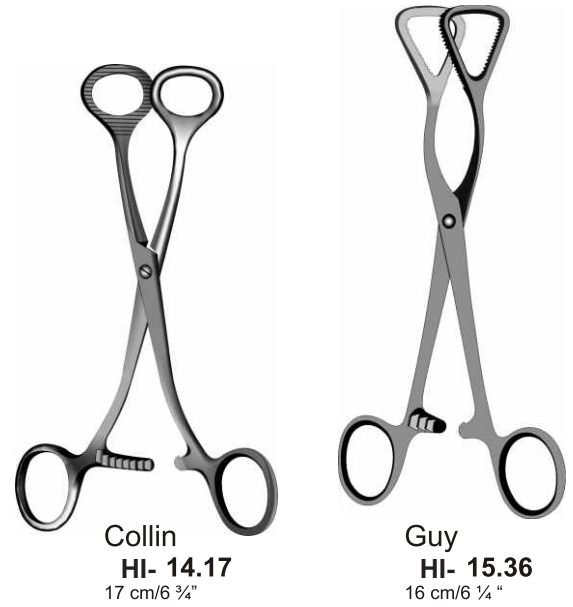
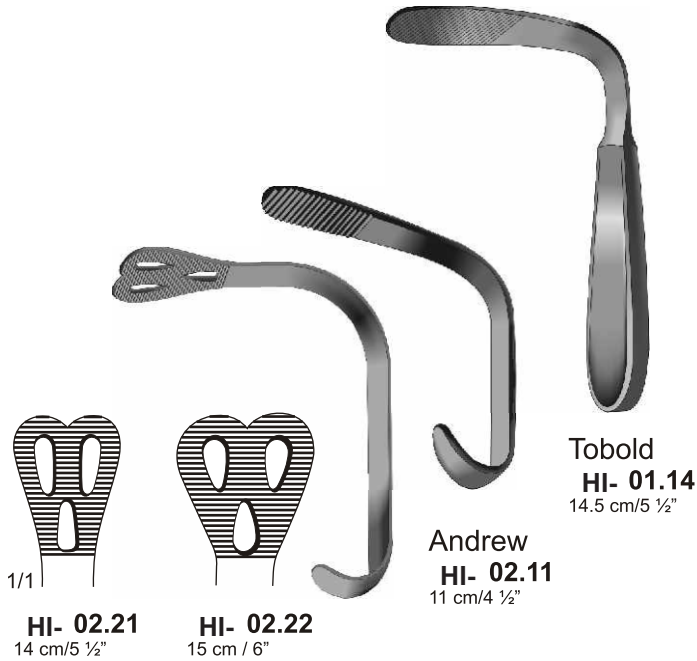



Needle Cases



**HI- 15.05** = 50 x 25 x 4,5 mm  
**HI- 15.08** = 65 x 42 x 8 mm  
**HI- 15.06** = 75 x 25 x 4,5 mm



**HI- 16.05** = 50 x 25 x 4,5 mm  
**HI- 16.08** = 65 x 42 x 8 mm  
**HI- 16.06** = 75 x 25 x 4,5 mm



Trays



**HI- 05.63**  
235 x 190 x 40 mm

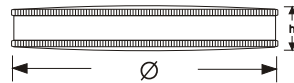

complete	insert only
<b>HI- 19.65</b> Ø = 65 mm h = 15 mm	<b>HI- 19.70</b> Ø = 62 mm h = 13 mm



**HI- 05.82**  
Ø 200 x 70 mm

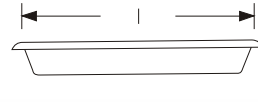
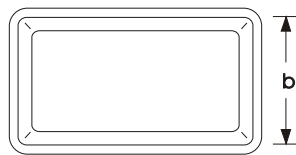

	l	b	h
<b>HI- 04.20</b>	200	150	38
<b>HI- 04.25</b>	250	200	50
<b>HI- 04.30</b>	300	250	50
<b>HI- 04.35</b>	355	305	50
<b>HI- 04.40</b>	405	305	50

**HI- 04.20- HI- 04.40**

Forceps Jars



Size in mm Ø X h	Jar without lid	Jar with lid
30 x 90	HI- 15.30	HI- 15.54
50 x 100	HI- 15.50	HI- 15.55
50 x 130	HI- 15.51	HI- 15.56
50 x 175	HI- 15.52	HI- 15.57
75 x 100	HI- 15.75	HI- 15.80
75 x 130	HI- 15.76	HI- 15.81
75 x 175	HI- 15.77	HI- 15.82
100 x 175	HI- 15.98	HI- 15.88
100 x 200	HI- 15.99	HI- 15.89

Instrument Box



**HI- 20.20**  
205 x 105 x 40 mm

Kidney Trays



Size in mm l x b x h		
170 x 100 x 35	<b>HI- 10.17</b>	17 cm/ 6 ¾"
250 x 140 x 40	<b>HI- 10.25</b>	25 cm/ 10"
275 x 150 x 45	<b>HI- 10.27</b>	27 cm/ 10 ¾"

Instrument Boxes



Size in mm  
L x w x h

165 x 85 x 35	<b>HI- 21.46</b>
200 x 100 x 35	<b>HI- 21.50</b>
200 x 100 x 50	<b>HI- 21.51</b>
230 x 130 x 50	<b>HI- 21.53</b>
260 x 150 x 50	<b>HI- 21.56</b>

270 x 235 x 50	<b>HI- 21.57</b>
300 x 200 x 50	<b>HI- 21.60</b>
325 x 275 x 30	<b>HI- 21.62</b>
325 x 275 x 50	<b>HI- 21.63</b>
420 x 80 x 40	<b>HI- 21.72</b>

420 x 175 x 50	<b>HI- 21.75</b>
----------------	------------------

Cotton Dispensers



**Methot**  
**HI- 35.01**      **HI- 35.02**  
ø50 x 75 mm  
With lid              Without lid



**Spirit Lamp**  
**HI- 19-1505**  
120 cc

Cotton wool containers



Size in mm      Lid with knob  
ø X h

75 x 60	<b>HI- 08.07</b>
75 x 75	<b>HI- 08.08</b>
100 x 60	<b>HI- 08.10</b>
100 x 100	<b>HI- 08.11</b>
125 x 80	<b>HI- 08.12</b>
125 x 125	<b>HI- 08.13</b>
150 x 100	<b>HI- 08.14</b>
150 x 150	<b>HI- 08.15</b>
200 x 100	<b>HI- 08.20</b>
200 x 150	<b>HI- 08.21</b>
200 x 200	<b>HI- 08.22</b>
240 x 160	<b>HI- 08.24</b>
240 x 230	<b>HI- 08.25</b>
290 x 160	<b>HI- 08.29</b>
290 x 240	<b>HI- 08.30</b>

Sterilization Drums



Schimmelbusch  
(Horizontal Ventilation)

Ø	h	
140 x 140 mm		HI- 25.14
160 x 150 mm		HI- 25.16
190 x 160 mm		HI- 25.19
190 x 190 mm		HI- 25.20
240 x 120 mm		HI- 25.24
240 x 160 mm		HI- 25.25
240 x 240 mm		HI- 25.27
290 x 160 mm		HI- 25.29
290 x 240 mm		HI- 25.30
340 x 160 mm		HI- 25.34
340 x 240 mm		HI- 25.35
390 x 140 mm		HI- 25.39
390 x 190 mm		HI- 25.40
390 x 290 mm		HI- 25.41



Konrich  
(Vertical Ventilation)

Ø	h	
140 x 140 mm		HI- 26.14
160 x 150 mm		HI- 26.16
190 x 160 mm		HI- 26.19
190 x 190 mm		HI- 26.20
240 x 120 mm		HI- 26.24
240 x 160 mm		HI- 26.25
240 x 240 mm		HI- 26.27
290 x 160 mm		HI- 26.29
290 x 240 mm		HI- 26.30
340 x 160 mm		HI- 26.34
340 x 240 mm		HI- 26.35
390 x 140 mm		HI- 26.39
390 x 190 mm		HI- 26.40
390 x 290 mm		HI- 26.41

Norm Trays

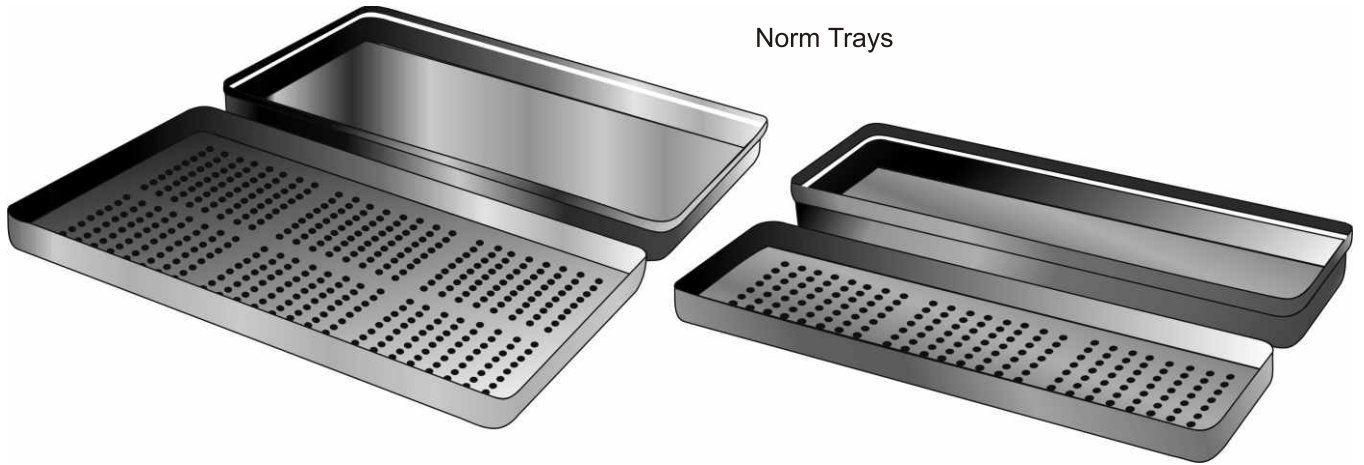

**HI-19-2101 - HI-19-2104**  
288 x 187 x 40 mm

**HI-19-2201 - HI-19-2204**  
288 x 93 x 40 mm

	Tablet	Lid	
HI-19-2101	Perforated	Unperforated	HI-19-2201
HI-19-2102	Unperforated	Unperforated	HI-19-2202
HI-19-2103	Perforated	Perforated	HI-19-2203
HI-19-2104	Unperforated	Perforated	HI-19-2204

Inserts for Trays

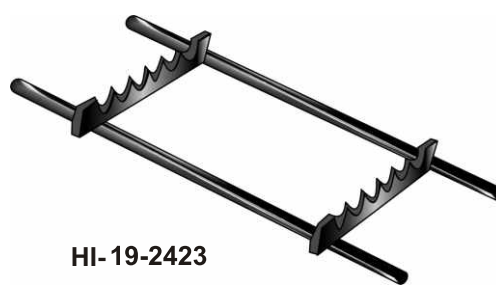
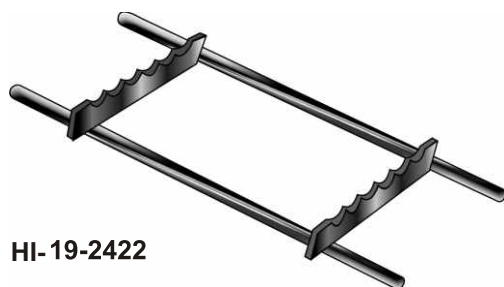
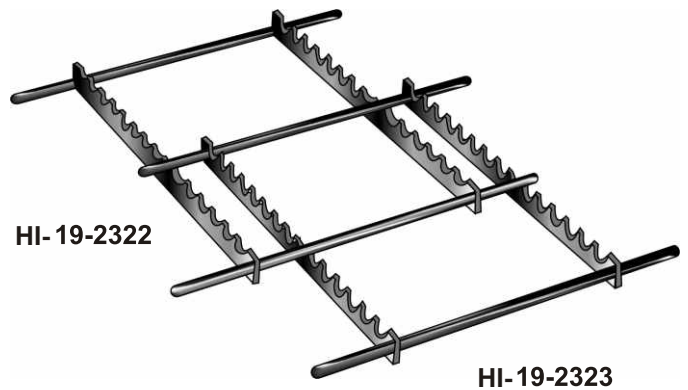
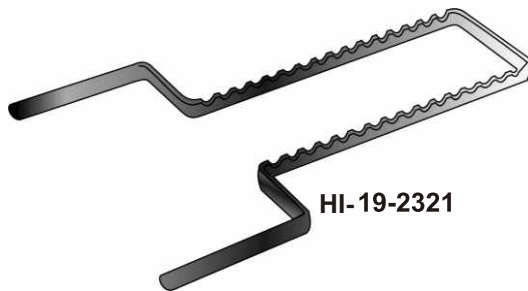



# CH 20

Surgery  
Chirurgie  
Chirurgia  
Chirurgie  
Chirurgia



With additional side holes

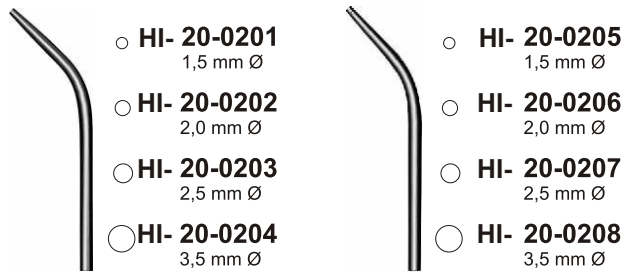

6 mm  
round

6 mm  
oval



- HI- 20-0301  
1,Ømm
- HI- 20-0302  
2,Ømm
- HI- 20-0303  
3,Ømm



Nuboer  
HI- 20-0121  
21 cm/8½"

Nuboer  
HI- 20-0122  
21 cm/8½"

Coupland  
HI- 20-0217  
17 cm/ 6 ¾"

Byrd  
HI- 20-0301-  
HI- 20-0303  
20 cm/ 8"

Cogswell  
HI- 20-0423  
23 cm/ 9"

Adson  
HI- 39.32  
4 mm  
21 cm/ 8 ½"

Frazier  
Charr. / Fr.  
HI- 36.86 6  
HI- 36.88 8  
HI- 36.90 10  
HI- 36.92 12  
19 cm/ 7 ½"

Yankauer  
HI- 30.00  
27 cm/ 11"

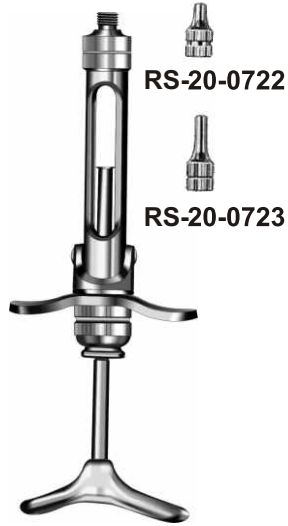

HI- 20-0702-1.8cc  
 HI- 20-0703-2.2cc  
 ( Complete with 2 tips )



HI- 20-0801



HI- 20-0802



HI- 20-0803



HI- 20-0804



HI- 20-0805



HI- 20-0900  
 1.8 ml



HI- 20-0806

Chiropody Instruments

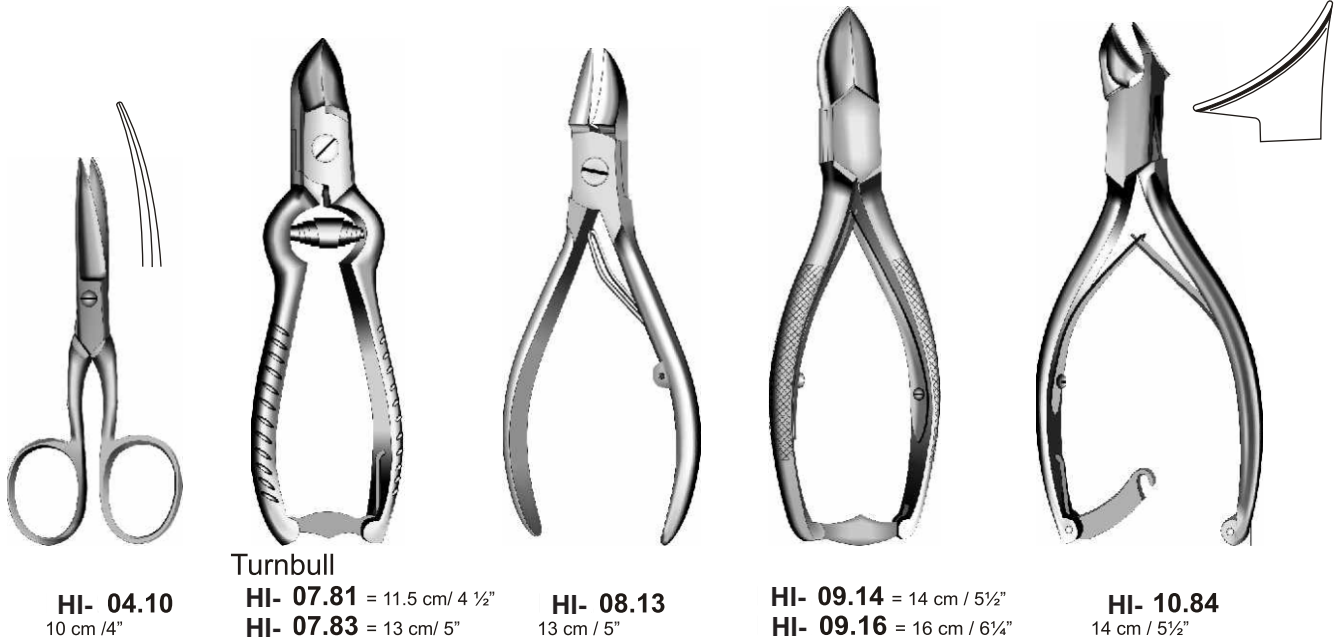

Sterilization Forceps

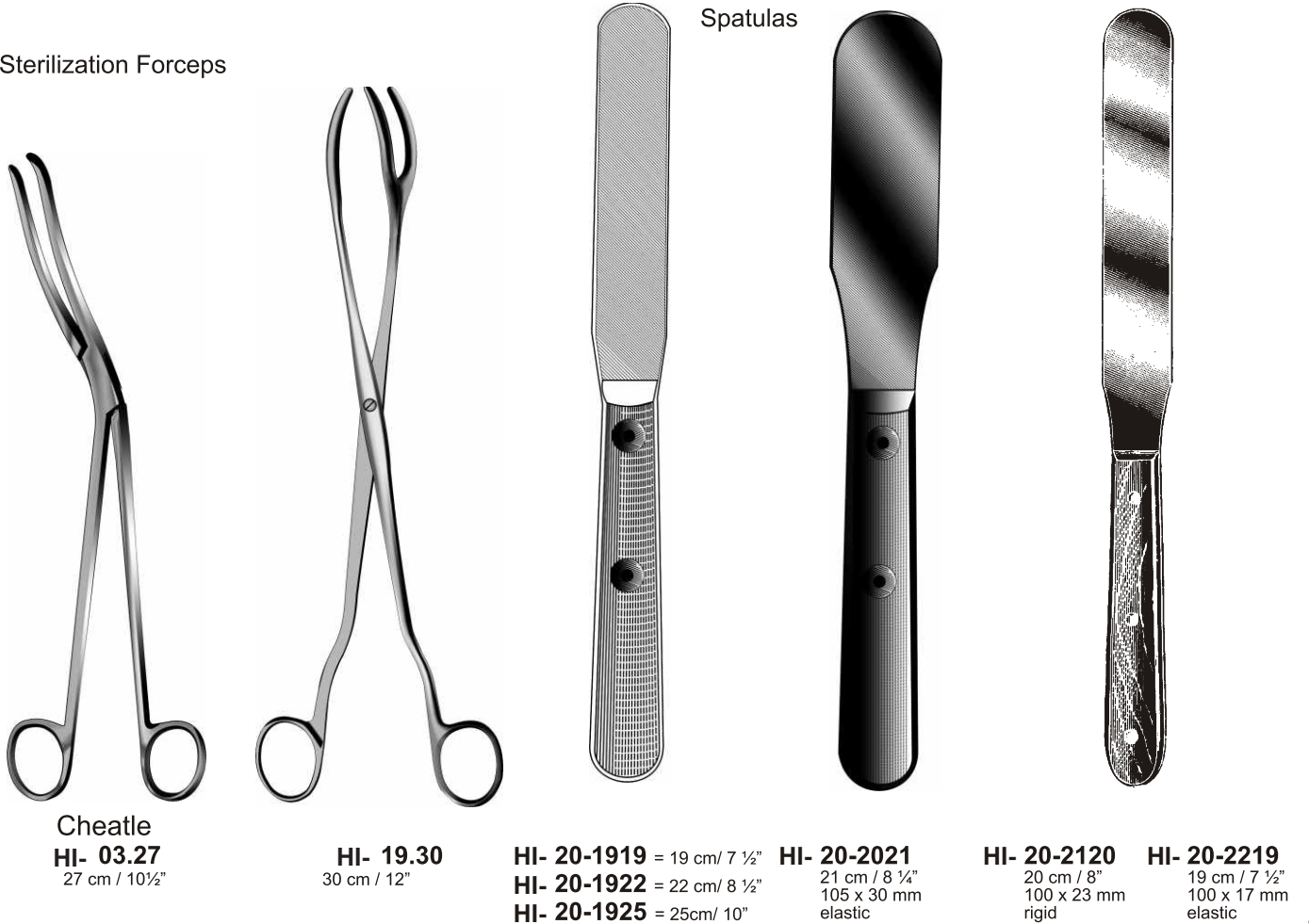

Napkin Holders

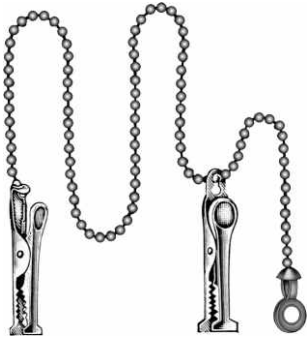

Professional  
HI- 20-2301  
length adjustable



Adams  
HI- 20-2302

Finger Guards



HI- 20-2401    HI- 20-2402    HI- 20-2403

Langenbeck  
HI-20-2401 - HI-20-2403

Sand glass



HI- 20-2500

Spring Caliper



HI- 20-2601



HI- 20-2602

Micro meters

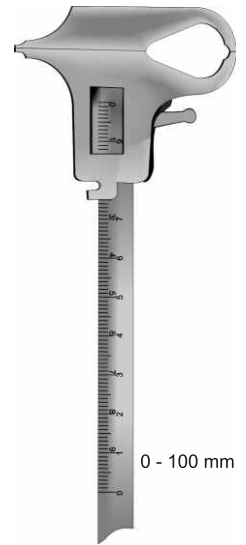

Boley  
HI- 20-2710



Iwanson  
HI- 20-2603



Iwanson  
HI- 20-2604

Oral wedge



Maunder  
HI- 64.10



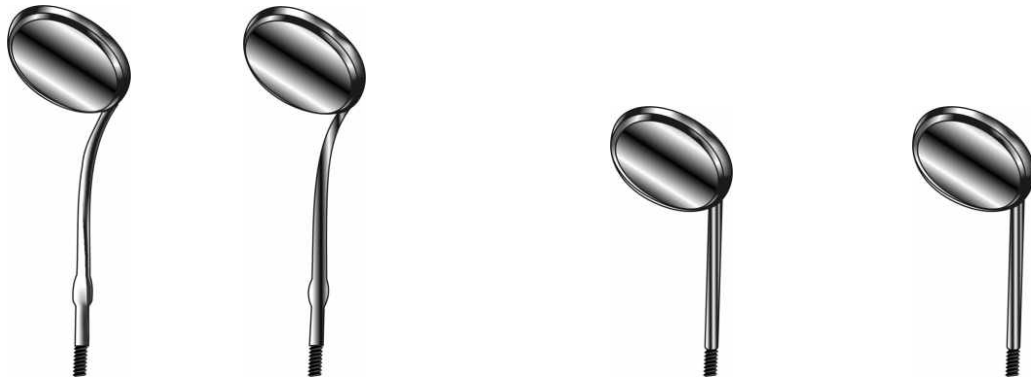

Ø mm	Sizes	Plane, Cone-Socket	Magnifying, Cone Socket	Ø mm	Sizes	Plane, simple thread	Magnifying, simple thread
22	4	<b>HI- 20-2922</b>	<b>HI- 20-3022</b>	22	4	<b>HI- 20-3122</b>	<b>HI- 20-3222</b>
24	5	<b>HI- 20-2924</b>	<b>HI- 20-3024</b>	24	5	<b>HI- 20-3124</b>	<b>HI- 20-3224</b>

Handles for mirrors

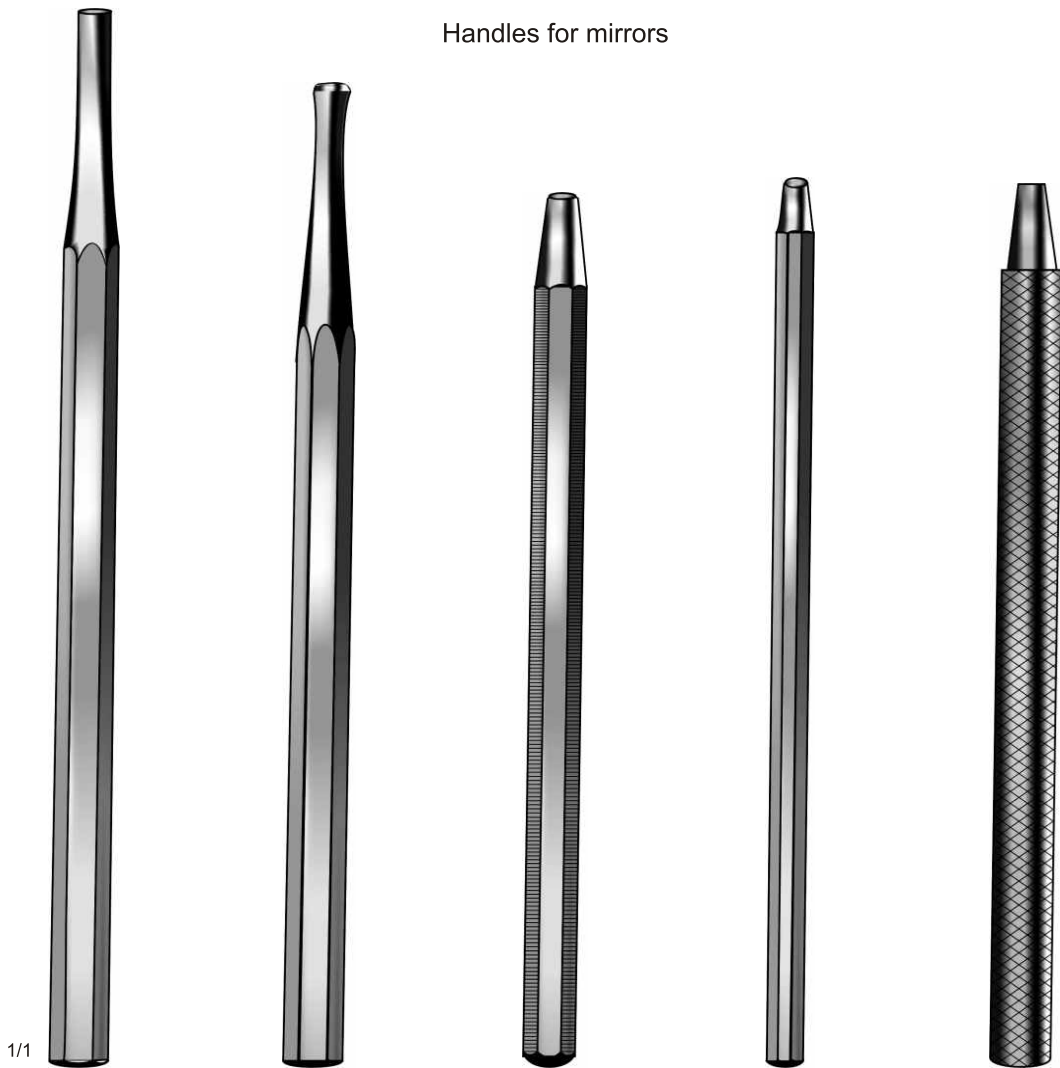

1/1	With simple thread <b>HI- 20-3301</b>	<b>Secco</b> <b>HI- 20-3401</b>	<b>HI- 20-3501</b>	<b>HI- 20-3601</b>	<b>HI- 20-3701</b>
	With Cone-Socket <b>HI- 20-3302</b>				

# CH 21

Dental instruments sets  
Satz Instrumente  
Sistema de instrumentos  
Ensemble d' instruments  
Insieme degli strumenti



Supplied in Leather wallets

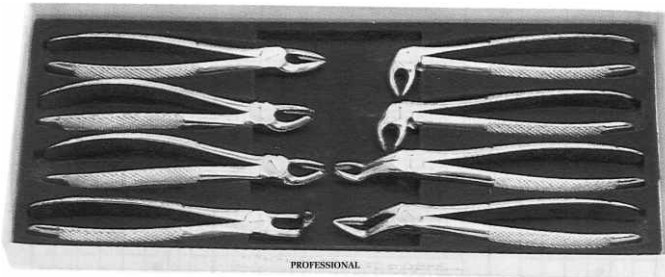

**HI- 21-0108**, Set of 8., Containing

- HI- 01-0101** Dental Extracting Forceps, No.1
- HI- 01-0113** Dental Extracting Forceps, No.13
- HI- 01-0117** Dental Extracting Forceps, No.17
- HI- 01-0118** Dental Extracting Forceps, No.18
- HI- 01-0751** Dental Extracting Forceps, No.51A
- HI- 01-1067** Dental Extracting Forceps, No.67
- HI- 01-1379** Dental Extracting Forceps, No.39

**HI- 21-0209** Set of 9, Containing

- HI- 01-0333** Dental Extracting Forceps, No.33
- HI- 01-0751** Dental Extracting Forceps, No.51A
- HI- 01-1067** Dental Extracting Forceps, No.67
- HI- 01-1379** Dental Extracting Forceps, No.79
- HI- 05-0203** Root Elevators, 3mm, 13.5 cm/ 5¼"
- HI- 05-2302** Root Elevators, No. 302
- HI- 05-2303** Root Elevators, No. 303
- HI- PJ.69.14** Mayo Hegar Needle Holder, 16 cm, T/C
- HI- PJ.23.56** Mathieu Needle Holder, 14cm, T/C

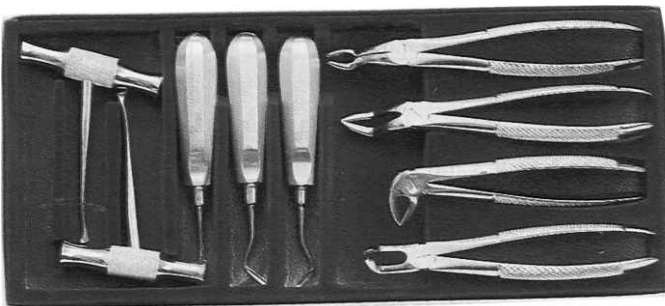
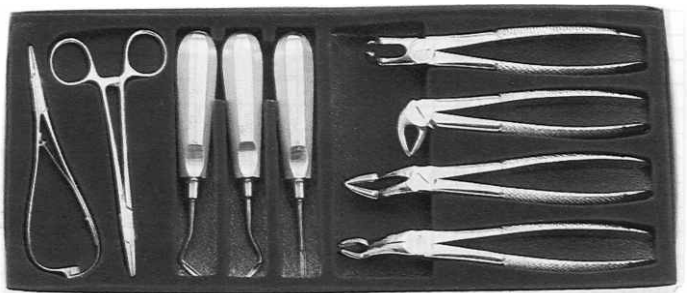

**HI- 21-0309** Set of 9 , Containing

- HI- 01-0333** Dental Extracting Forceps, No.33
- HI- 01-0751** Dental Extracting Forceps, No.51
- HI- 01-1067** Dental Extracting Forceps, No.67
- HI- 01-1379** Dental Extracting Forceps, No.79
- HI- 05-0203** Root Elevators, 3mm, 13.5 cm/ 5¼"
- HI- 05-2302** Root Elevators, No. 302
- HI- 05-2303** Root Elevators, No. 303
- HI- 05-4320** Dental Extracting Forceps, No.320
- HI- 05-4321** Dental Extracting Forceps, No.321

**HI- 21-0408** Set of 8, Containing

- HI- 01-0101** Dental Extracting Forceps, No.1
- HI- 01-0104** Dental Extracting Forceps, No.4
- HI- 01-0107** Dental Extracting Forceps, No.7
- HI- 01-0113** Dental Extracting Forceps, No.13
- HI- 01-0117** Dental Extracting Forceps, No.17
- HI- 01-0118** Dental Extracting Forceps, No.18
- HI- 01-0220** Dental Extracting Forceps, No.20
- HI- 01-1686** Dental Extracting Forceps, No.6C



## Periodontal Instruments Set

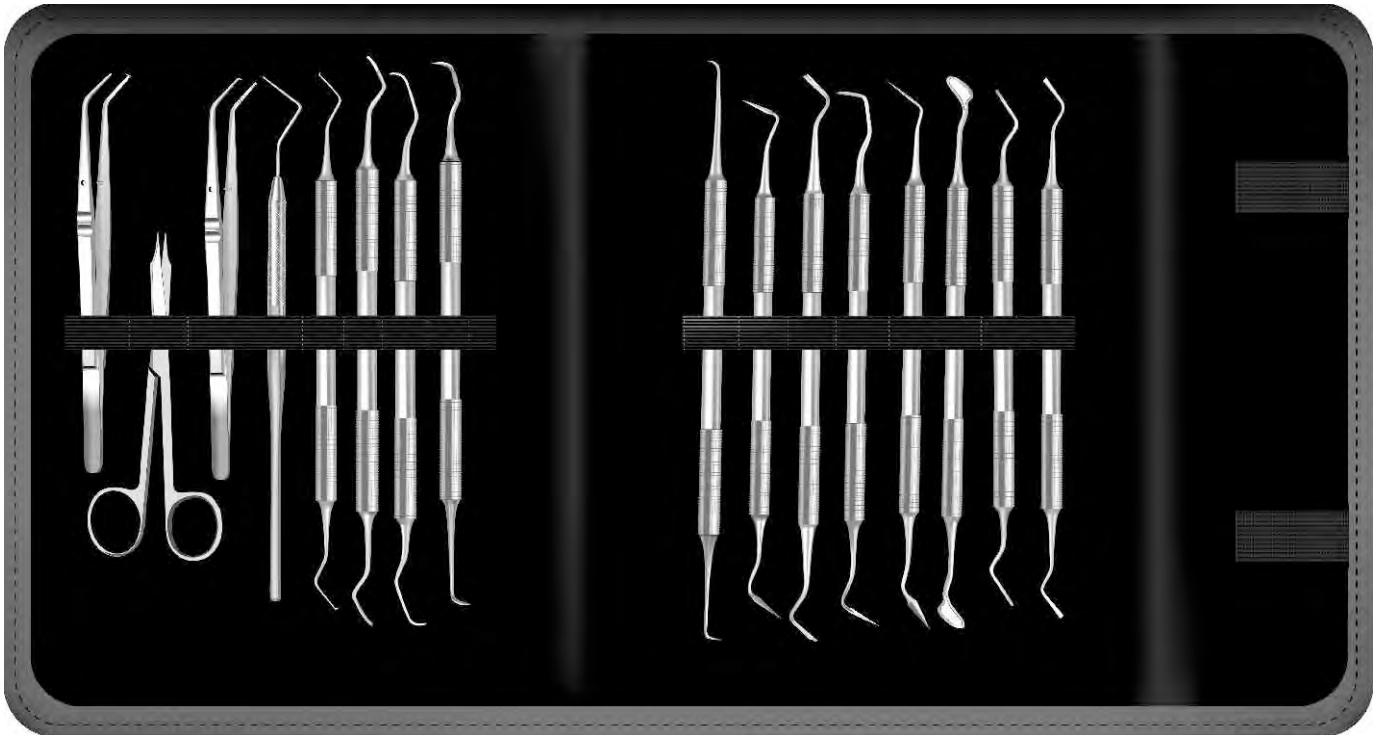

**HI- 21-0508** Set of 16 Periodontia Instruments, Containing in artificial Leather case :

- HI- 08-2101** Goldman-Fox Curettes 16cm/ 6 1/4"
- HI- 08-2102** Goldman-Fox Curettes 16cm/ 6 1/4"
- HI- 08-2103** Goldman-Fox Curettes 16cm/ 6 1/4"
- HI- 08-2104** Goldman-Fox Curettes 16cm/ 6 1/4"
- HI- 08-2105** Goldman-Fox Curettes 16cm/ 6 1/4"
- HI- 08-2106** Goldman-Fox Curettes 16cm/ 6 1/4"
- HI- 08-1507** Goldman-Fox Knives
- HI- 08-1508** Goldman-Fox Knives
- HI- 08-1509** Goldman-Fox Knives
- HI- 08-1510** Goldman-Fox Knives
- HI- 08-1511** Goldman-Fox Knives
- HI- 08-1521** Goldman-Fox Knives
- HI- PC.90.13** Goldman Fox, Gum Scissors 13 cm/ 5 1/8"
- HI- 15-3301** Crane-Keplan Dental Tweezers 14 cm/ 5 1/2"
- HI- 15-3302** Crane-Keplan Dental Tweezers 14 cm/.5 1/2"

	<i>Page</i>		<i>Page</i>
<b>A</b>			
Abell Pliers, Contouring	89	Crane-Kaplan Dental Tweezers	104
Adams Napkin Holders	129	Crane-Kaplan Gingivectomy Knives	51
Adams Pliers, Wire, Arch and Clasp Bending	89,94	Crile-Wood Needle Holders	107
Aderer Pliers, Wire, Arch and Clasp Bending	89,93	Crile-Wood Needle Holders, TC	108
Adson Forceps, Dissecting TC	102	Cross Periodontia Instruments	53
Adson Forceps, Dressing	102	Crown Instruments	71,72
Adson Forceps, Tissue	102	Cryer Extracting Forceps, American Pattern	23
Adson Suction Tubes	126	Cryer Root Elevators	28
Adson-Brown Forceps	102	Cups, Finger	36
Ainsworth Rubber Dam Instruments	74	Curettes, Bone	115-117
Albrecht Dental Tweezers	104	Curettes, Universal	47,48
Allis Forceps, Tissue and Organ Holding	106	Cushing Forceps, Dissecting, TC	102
Allis-Baby Forceps, Tissue and Organ Holding	106	Cutting Instruments	66
Amalgam Instruments	35-37		
Andrew Tongue Depressors	118	<b>D</b>	
Angle Pliers, Wire, Arch and Clasp Bending	89,94	Darby-Perry Excavators	60
Apical Flohr Root Elevators	28	Darby-Perry Scalers	46
Apical Root Elevators	28	Davis-Boyle Mouth Gags	118
Articulating Forceps	104	De La Rosa, Pliers	91
Ash Gum Knives	98	Dean Gum Scissors	100
Ash Plastic Filling Instruments	39	Dean Gum Scissors, TC	101
Axial Filling Instruments	40,41	Decimal Spring Calipers	129
		Denhart Mouth Gag	114
<b>B</b>			
Babcock Forceps, Tissue and Organ Holding	106	Derf Needle Holders, TC	108
Baby-Crile Needle Holders	108	Diamant End and Side Nipper	89
Backhaus Towel Forceps	105	Dispenser, Gauze and Cotton	122
Barnhart Universal Curettes	48	Dividing Compasses	129
Bates Universal Curettes	48	Dressing Forceps	102,105
Beale Wax, Porcelain and Modelling Carvers	70	Drums, Sterilization	123
Bein Root Elevators	27	Dumont Pliers	88
Bennet Plastic Filling Instruments	38		
Beyer Forceps, Bone Rongeur	112	<b>E</b>	
Black Cutting Instruments	66	Ehrlicke Stainless Steel Impression Trays	85-86
Blumenthal Forceps, Bone Rongeur	112	Elevators & Raspatories	111
Bohler Bone Rongeurs	112	Elevators, Root	27-32
Bohn Crown Instrument	72	Ermer Wax Knife	70
Boley Sliding Caliper	129	Excavators	58-61
Bone Curettes	115-117	Explorers	62-63
Bow Compasses	129	Extracting Forceps for Children, American Pattern	15
Bowls, Kidney	121	Extracting Forceps for Children, English Pattern	12-14
Bowls, Round	120	Extracting Forceps	2-24
Bowmann Lacrimal Probes	113	Extracting Forceps, with Alfa handle	11
Boxes, Instrument	121,122	Extracting Forceps, American Pattern	16-24
Brewer Rubber Dam Instruments	74	Extracting Forceps, English Pattern	2-10
Bruenings Tongue Depressors	113		
Bunting Universal Curettes	48	<b>F</b>	
Burnishers	42	F.Barry Root Elevators	30
Byrd Suction Tubes	126	Farabeuf Retractors, Soft Tissue	109
		Farrell Cotton Applicators	113
<b>C</b>			
Calipers	129	Fedi Periodontia Instruments	55
Cartridge Syringes	127	Fehnenstock, Wax Knife	70
Cases, Needle Sterilizing	120	Files	66
Castroviejo Needle Holder	107	Finger Protectors	129
Caulk Dental Tweezers	104	Flagg Dental Tweezers	103
Cement Spatula	43,44	Flohr Root Elevators	28
Cheatle Forceps, Sterilizing	128	Forceps	102-106
Chip Blowers	127	Forceps, Artery	105,106
Chiroprody Instruments	128	Forceps, Bone Cutting	112
Chisels, Bone	115	Forceps, Bone Rongeur	112
Chompret Root Elevators	29	Forceps, Dissecting, TC	102
Citelli Bone Rongeurs	111	Forceps, Splinter	106
Cleveland Forceps, Bone Cutting	112	Forceps, Sterilizing	128
Cogswell Suction Tubes	126	Forceps, Tissue and Organ Holding	106
Coleman Root Elevators	29	Forceps, Tissue	102,106
Collin Forceps, Tongue Holding	118	Forceps, Tongue Holding	118
Collin Mallets	116	Forceps, Towel	105
Collin-Hartmann Retractors, Soft Tissue	109	Frahm Wax, Porcelain & Modelling Carver	68
Columbia Scalers & Curettes	47	Frazier Skin Hook	109
Containers for Cotton Wool	122	Frazier Suction Tubes	126
Cottle Bone chisels	115	Freer Elevator	111
Cotton Applicators	113	Friedman Forceps, Bone Rongeur	111
Cotton Dispenser	122	Friedman Root Elevators	26
Coupland Root Elevators	27	Furrer pliers, Copper Ring and Bridge Removing	90
Coupland Suction Tubes	126		
Crane Pick Root Elevators	28		



	<i>Page</i>		<i>Page</i>
<b>G</b>			
Gauze Packers	113	Lecluse Root Elevators	31
Gillies Needle Holder	107	Locklin Gum Scissors	100,101
Gillies Needle Holders, TC	108	Locklin Gum Scissors, TC	101
Gillies Skin Hooks	109	Lodo Pliers, Copper Ring and Bridge Removing	90
Gingivectomy Knives	51	London College Tweezers, Cotton	103
Gisy-Wild Wax, Porcelain and Modelling Carver	70	Lowrence Read, Extracting Forceps	08
Goldman Fox Periodontia Instruments	53,54	Lucas Bone Curettes	117
Goldman Universal Curettes	48	Luer Forceps, Bone Rongeur	112
Gracey Periodontia Instruments	56	Luks Nerve Instruments	65
Gross-Maier Dressing & Cotton Swab Forceps	105	Luniatckek Gauze Packers	113
Gum Knives	98		
Gum Scissors	100	<b>M</b>	
Guthrie Skin Hooks	109	Mallery Universal Curettes	48
Guy Tongue Holding Forceps	118	Mallets	116
		Mathieu Needle Holders	107
<b>H</b>			
Halsey Needle Holders, TC	108	Mathieu Needle Holders, TC	108
Halsted-Mosquito Artery Forceps	105	Matrix Bands	73
Handle for Mouth Mirrors	130	Matrix Retainers	73,74
Harris Extracting Forceps, American Pattern	17-18	Maunder Wedges, Oral	129
Hartmann Forceps, Artery	105	Mayo Hegar Needle Holders	107
Heidebrink Root Elevators	29	Mayo Hegar Needle Holders, TC	108
Heidemann Plastic Filling Instruments	39	Mayo Tongue Depressors	113
Heister Mouth Gags	114	McCall Periodontia Instruments	52
Hemingway Mod Bone Curettes	116	McCall Scalars	46
Henahan Extracting Forceps, American Pattern	16	Mclvor Mouth Gags	118
Hirschfeld Files	66	Mckellops Pliers	95
Hollenback Amalgam Instruments	37	Mead Extracting Forceps	10
Hollenback Wax, Porcelain & Modelling Carvers	68	Mead Mallets	116
Hooks, Skin	109	Measuring Instruments	129
How Pliers	89,94	Meriam Tweezer, Cotton and Dressing	103
Hull Extracting Forceps, American Pattern	21	Mershon Instruments for Crown Work	71
Hygenist Periodontia Instruments	52	Methot Dispensers, Gauze and Cotton	122
Hyllin Root Elevators	27	Metzenbaum Delicate Scissors, Dissecting	99
Hyllin Wax Knife	69	Metzenbaum Delicate Scissors, TC	101
		Metzenbaum Scissors, Dissecting	99
<b>I</b>			
Impression Trays	76-86	Micrometers	129
Indiana University Universal Curettes	48	Micro-Ryder Needle Holder TC	108
Instruments for Crown Work	71,72	Miller Paper Clip	71
Interproximal Wax, Porcelain & Modelling Carvers	68	Miller Root Elevators	28
Ivory Amalgam Instruments	36	Miller-Colbrun Bone Curettes	117
Ivory Matrix Retainers	73,74	Mirrors, Mouth	130
Iwanson Decimal Spring Calipers	129	Mod. PHF Bone Curettes	116
		Mod. Plastic Filling Instruments	38,40
<b>J</b>			
Jaquette Periodontia Instruments	52	Mod. USA Amalgam Instruments	37
Jaquette Scalars	46	Molt Mouth Gag	114
Jarabak Pliers	93	Molt Raspatories, Periosteal	111
Jars, Forceps	121	Mouth Gags	114,118
Jennings Mouth Gags	114		
Johnson Pliers, Contouring	89	<b>N</b>	
Jones Towel Forceps	105	Nabers Pernodontia Instruments	53
		Napkin Holders	129
<b>K</b>			
Kells Extracting Forceps, American Pattern	22	Needle Cases	120
Kelly Gum Scissors, TC	101	Needle Holders	107,108
Kerrison Bone Rongeurs	111	Needle Holders, TC	108
Keyes Dermal Punch	113	Nerve Instruments	64,65
Kidney Trays	121	Nevious Extracting Forceps, American Pattern	21,22
Kilner Skin Hook	109	Nippers, Cuticle	128
Kirkland Gingivectomy Knives	51	Nippers, Nail	128
Klein Extracting Forceps for Children, with Spring	14	Norm Trays	124
Knives & Scalpels	98	Nuboer Suction Tubes	126
Konrich Sterilizing Drums	123		
Krallengnber Elevators	31	<b>O</b>	
Kroenig Tongue Depressors	113	Obwegeser Retractors, Soft Tissue	110
		Ochsenbein Periodontia Instruments	55
<b>L</b>			
La Grange Gum Scissors	100	Ochsner-Kocher, Hemostatic Forceps	106
Langenbeck Elevators	111	Olsen Hegar Needle Holders	107
Langenbeck Finger Protectors	129	Olsen-Hegar Needle Holders, TC	108
Langenbeck Retractors	110	Oringer Self retaining Cheek Lip Retractors	114
Langer Scalars & Curettes	47		
Le Cron Wax, Procelain & Modelling Carvers	70	<b>P</b>	
		Parly Extracting Forceps, American Pattern	19
		Partsch Chisels, Bone	115
		Passow Bone Chisels	115
		Periodontia Instruments	50-56
		Perry Dental Tweezers	103
		Physick Extracting Forceps, American Pattern	16

	<i>Page</i>		<i>Page</i>
Plastic Filling Instruments	38-41	Suction Tubes	126
Pliers, Bond Bracket	91,92	Surgery Instruments	125-130
Pliers, Contouring	89	Syringes Cartridges	127
Pliers, Copper Ring and Bridge Removing	90	Syringes, Water	127
Pliers, Crown	89		
Pliers, Flat Nose	88	<b>T</b>	
Pliers, Loop Forming & Bending	94,95	Thomas Modelling Carvers	69
Pliers, Orthodontic	88-96	Tobold Tongue Depressors	118
Pliers, Bar Bending	88	Tofflemire Matrix Bands	73
Pliers, Band Seating	91	Tofflemire-Universal Matrix Retainers	73
Pliers, Universal	90	Tomes Extracting Forceps	20
Pliers, Wire Arch and Clasp Bending	89,91-93	Tongue Depressors	113,118
Pliers, Wire Cutting Pliers	96	Towner Jaquette Periodontia Instruments	52
Pott Root Elevators	31	Trays, Half	124
Prichard Periodontia Instruments	53	Trays, Instruments Storing	120
Probes (Explorers)	62-63	Trays, Norm	124
Probes Periodontia	50	Trays, Universal	100
Professional Napkin Holders	129	Treyemann Instruments for Crown Work	71
		Tuft Wax, Porcelain and Modelling Carvers	68
<b>Q</b>		Turnbull Nipper, Nail	128
Quinby Gum Scissors	100	Tweed Bending & Forming Pliers	93,95
		Tweezers, Cotton & Dressing	103,104
<b>R</b>		<b>U</b>	
Ragnell (Kilner) Gum Scissors, TC	101	Universal Curettes	47,48
Ralk Forceps, Splinter	106	Universal Pliers	90
Raspatories, Periosteal	111	Universal Wire and Crown Scissors	100,101
Retractors	109-110	USA-Mod Dental Tweezers	104
Retractors, Cheek and Lip	113		
Retractors, Soft Tissue	110	<b>V</b>	
Reynolds Pliers	89,93	Vestibulum-Haken	114
Rochester-Pean Hemostatic Forceps	106	Volkman Bone Curettes	115
Root Elevators	26-32	Volkman Retractors	110
Roser Konig Mouth Gag	114		
Roux Retractors	109	<b>W</b>	
Rubber Dam Instruments	74	Wagner Gum Scissors	100
Rule Universal Curettes	48	Waldsachs-Universal Pliers	90
		Walter F.Barry Root Elevators	28,30,32
<b>S</b>		Ward Wax, Porcelain and Modelling Carver	68
Sachs Instruments for Crown Work	71	Ward-Kirkland Periodotia instruments	51
Sand Glass	129	Warwick James Root Elevators	32
Scalers	46-48	Wax, Porcelain and Modelling Carvers	68-70
Scalpel Handles	98	Wedges, Oral	129
Scalpel Blades	98	Weingart Pliers	94
Schimmelbusch Sterilizing Drums	123	West Root Elevators	32
Schroeder Instruments for Crown Work	71	White Burnishers	42
Schwarz Pliers, Bar Bending	88	White Excavators	59
Scissors	99-101	White Plastic Filling Instruments	39
Scissors, Cuticle	128	Wieder Tongue Depressors	118
Scissors, Dissecting	99,101	Wiland Wax, Porcelain and Modelling Carvers	68
Scissors, Gum	99,100	Williams Plastic Filling Instruments	38
Scissors, Gum, TC	101	Williger Bone Curettes	115
Scissors, Nail	128	Williger Elevators	111
Scissors, Operating Fine	99	Winter Root Elevators	30
Scissors, Operating	99	Woodson Plastic Filling Instruments	39
Scissors, TC	99,101	Woodward Extracting Forceps	17
Scissors, Wire and Crown	100,101		
Seldin Root Elevators	28	<b>Y</b>	
Semken Tissue Forceps	102	Yankauer Suction Tubes	126
Senn-Miller Retractors	109	Yonger Good Universal Curettes	48
Sets, Dental Instruments	132,133	Young Pliers, Wire, Arch and Clasp Bending	89
Sliding Caliper	129		
Spatulas	128	<b>Z</b>	
Spatulas, Cement	43,44,128	Zahle Wax Knife	69
Spirit Lamp	122		
Spring Calipers	129		
Stadler Pliers	89		
Standard Extracting Forceps, American Pattern	16-24		
Standard Forceps, Dressing	102		
Standard Scalpel Handles	98		
Standard Scissors, Operating	99		
Sterilization	119-124		
Sterilizing Drums	123		
Sternberg Raetractors, Cheek and Lip	113		
Stieglitz Splinter Forceps	106		
Stockes Rubber Dam Instruments	74		



Inquiry now Today!

Inquiry now Today Call us!  
Cell# **+92 319 1831970**

for Email  
[info@huzaifaitl.com](mailto:info@huzaifaitl.com)

Shahid hamber, Nawa pind araiyan  
Defence road, Sialkot, Pakistan.

[www.huzaifaitl.com](http://www.huzaifaitl.com)